

1-275 R 4C 1274
CHARD B FONES JR
BALTIMORE-ANNAPOLIS
VD-FERNDALE
MEN BURNIE MD 21061

January, 1976 □ 75 cents

Electronic Servicing



A HOWARD W. SAMS PUBLICATION

SERVICING MICROWAVE OVENS



1975 Index
Installing CB Antennas
XL-100 Horizontal Oscillator

You've Got Us Where You Want Us



Even though we're the world's largest tuner repair service, recommended by more TV manufacturers than any other company, we think small. Really! We could put the whole thing under one roof. Instead, we have 36 small service centers across the country, staffed by more than 200 professional technicians. Why? Service for one thing . . . same-day

service. Bring us a tuner . . . any tuner . . . at 8 a.m. and it's repaired and tested by 4 p.m. Then there's quality . . . original parts, and once repaired, it's good as new. Oh sure, being the world's largest is something we're proud of. But we also like the fact that with 36 service locations, we can be small enough to give every tuner repair job a personal as well as a professional touch.



ELECTRONICS, INC.

PRECISION TUNER SERVICE

Consult the white pages of your telephone directory for the address and telephone number of the PTS center nearest you.

For More Details Circle (1) on Reply Card

Buss® Fuses Specialize Too!

in the protection of

CB

EQUIPMENT

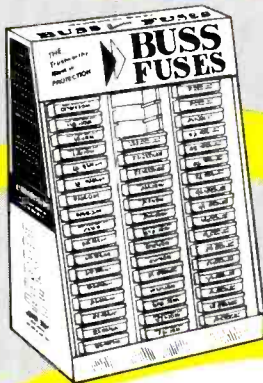

No. 240CB-3
Metal Display Stand



No. 80CB-1
Metal Display Stand

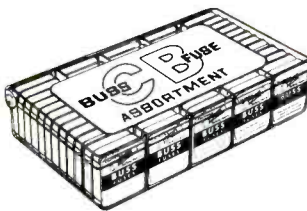

No. 240CB-4
Plastic Display Box

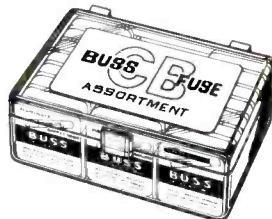

No. 80CB-2
Plastic Display Box

Now . . . four new BUSS fuse assortments exclusively designed with replacement fuses to service most Citizen Band Radios — offering a whole new area of opportunities for increased profits.

Two assortments contain 48 — 5 in metal boxes (240 fuses). BUSS No. 240CB-3 fuse assortment comes in a handy metal display stand. BUSS No. 240CB-4 fuse assortment is packed in a compact plastic display box.

In addition, there are two fuse assortments containing 16 — 5 in metal boxes (80 fuses). BUSS No. 80CB-1 fuse assortment packed in a metal display stand and BUSS No. 80CB-2 fuse assortment in a plastic display box.

Both BUSS fuse assortments contain a careful selection of the most popular fuses used in CB radios.

CB dealers can now have the fuses they need in a neat complete package to service all their customers fuse needs.

For full fuse assortment details, write for BUSS Bulletin CBA.



BUSSMANN MANUFACTURING
a McGraw-Edison Company Division
St. Louis, Missouri 63107



electronicscanner

news of the industry

NATESA Secretary General Leo P. Shumavon passed away November 18th, 1975. He has held many offices in NATESA, and will be sadly missed.

Olympic International recently purchased **General Electric's** inventory of color and monochrome TV sets made originally for **W. T. Grant's** private-label Bradford line. According to **Home Furnishings Daily**, Olympic may sell the sets under the Bradford name but can't advertise that they're GE made. The sets are not warranted by GE or Grant.

The Solid State Division of RCA is the first semiconductor manufacturer to qualify an integrated circuit under specification MIL-M-38510, class A to the U.S. government. This approval, given by the Defense Electronics Supply Center (DESC), applies to four RCA integrated circuits, which are of the complementary-symmetry metal-over-oxide (CMOS) type. Some typical applications include their use in medical-electronic equipment, remote unmanned telecommunication stations, commercial communication satellites, and critical-process control systems.

A new clothes dryer using positive-temperature-coefficient (PTC) thermistors is being developed by Hitachi. Each PTC is about the size of a half dollar, explains **Home Furnishings Daily**, and is heated by electric power. Increasing heat also increases the resistance, so the temperature stabilizes at about 175 degrees Centigrade, thus serving as its own temperature regulator.

A 91.7 % rating for serviceability has been awarded the **General Electric YC solid-state modular color chassis** by a five-member panel from the International Society of Certified Electronic Technicians (ISCET), which is affiliated with the National Electronic Service Dealers Association (NESDA). CET's participating in the review were Dean Mock, Dick Glass, Lew Edwards, Jesse Leach, and John McPherson. According to Dick Glass, the committee found the overall serviceability of GE's YC chassis to be "excellent".

A two-day **Basic MATV School** recently held in Chicago by **Jerrold Electronics** attracted 58 participants. Topics covered by teacher Jerry Schwartz included: decibels; noise level; TASO signal-to-noise qualifications; path loss; gain; output capability, and overload. In addition, each student learned how to design complete MATV systems for large buildings.

(Continued on page 6)

TUNER SERVICE CORPORATION

SUBSTITUNER

JUST

\$44.95
U.S.A. ONLY

WITH CABLES



ONE YEAR
GUARANTEE

STILL ONLY

\$9.95
U.S.A. ONLY



MAJOR PARTS
AND SHIPPING
CHARGED AT COST

FEATURES

- A UHF Tuner with 70 channels which are detented and indicated just like VHF channels.
- A VHF Hi Gain Solid State Tuner.
- AC Powered
- 90 Day Warranty

Demonstrate the **SUBSTITUNER** to your customers and show improved reception with their TV sets.

You may place your order through any of the Centers listed below.

PROVIDES YOU WITH A COMPLETE SERVICE FOR ALL YOUR TELEVISION TUNER REQUIREMENTS.

REPAIR

VHF OR UHF ANY TYPE (U.S.A. ONLY) \$ 9.95
UHF/VHF COMBINATION (U.S.A. ONLY) \$15.00

MAJOR PARTS AND SHIPPING
CHARGED AT COST

- Fast, efficient service at our conveniently located Service Centers.
- All tuners are ultrasonically cleaned, repaired, realigned, and air tested.

REPLACE

UNIVERSAL REPLACEMENT TUNER \$12.95 (U.S.A. only)

- This price buys you a complete new tuner built specifically by Sarkes Tarzian Inc. for this purpose.
- All shafts have a maximum length of 10½" which can be cut to 1½".
- Specify heater type parallel and series 450 mA. or 600 mA.

CUSTOMIZE

- Customized tuners are available at a cost of only \$15.95. With trade-in \$13.95. (U.S.A. only)
- Send in your original tuner for comparison purposes to any of the Centers listed below.



HEADQUARTERS	BLOOMINGTON, INDIANA 47401	537 South Walnut Street	Tel. 812-334-0411
ARIZONA	TUCSON, ARIZONA 85710	1528 S. 6th Ave.	Tel. 602-791-9243
CALIFORNIA	NORTH HOLLYWOOD, CALIF. 91601	10654 Magnolia Boulevard	Tel. 213-769-2720
	BURLINGAME, CALIF. 94010	1324 Marsten Road	Tel. 415-347-5728
	MODESTO, CALIF. 95351	123 Phoenix Avenue	Tel. 209-521-8051
FLORIDA	TAMPA, FLORIDA 33606	1505 Cypress Street	Tel. 813-253-0324
	FT. LAUDERDALE, FLORIDA 33315	104 S.W. 23rd St., Box 18	Tel. 306-524-0914
GEORGIA	ATLANTA, GA. 30310	646 Evans St. S.W.	Tel. 404-756-2232
ILLINOIS	CHAMPAIGN, ILLINOIS 61820	405 East University Street	Tel. 217-356-6400
	SKOKIE, ILLINOIS 60076	5110 West Brown Street	Tel. 312-675-0230
INDIANA	INDIANAPOLIS, INDIANA 46204	112 West St. Clair Street	Tel. 317-632-3493
IOWA	DES MOINES, IOWA 50319	5005 Douglas St. #5E	Tel. 515-278-4217
KENTUCKY	LOUISVILLE, KENTUCKY 40205	2244 Taylorsville Road	Tel. 602-452-1191
LOUISIANA	SHREVEPORT, LOUISIANA 71104	3025 Highland Avenue	Tel. 318-221-3027
MARYLAND	BALTIMORE, MARYLAND 21215	5505 Reisterstown Rd., Box 2624	Tel. 301-358-1186
MASSACHUSETTS	SPRINGFIELD, MASS. 01108	405 Dickinson St.	Tel. 413-788-8206
MISSOURI	ST. LOUIS, MISSOURI 63132	10530 Page Avenue	Tel. 314-429-0633
NEVADA	LAS VEGAS, NEVADA 89102	1412 Western Avenue No. 1	Tel. 702-384-4235
NEW JERSEY	TRENTON, NEW JERSEY 08638	1139 Pennsylvania Ave.	Tel. 609-393-0999
	JERSEY CITY, NEW JERSEY 07307	547-49 Tonelle Ave., Hwy. 1 & 9	Tel. 201-792-3730
N. CAROLINA	GREENSBORO, N.C. 27405	2914 E. Market Street	Tel. 919-273-6276
OHIO	CINCINNATI, OHIO 45216	7450 Vine Street	Tel. 513-821-5080
	CLEVELAND, OHIO 44109	4525 Pearl Road	Tel. 216-741-2314
OREGON	PORTLAND, OREGON 97210	1732 N.W. 25th Avenue	Tel. 503-222-9059
PENNSYLVANIA	PITTSBURGH, PA. 15209	503 1/2 Grand Avenue	Tel. 412-821-4004
TENNESSEE	MEMPHIS, TENNESSEE 38111	3158 Barton Avenue	Tel. 901-458-2355
TEXAS	DALLAS, TEXAS 75218	14540 Garland Road	Tel. 214-327-8413
VIRGINIA	NORFOLK, VIRGINIA 23513	3235 Santos Street	Tel. 804-855-2518
CANADA	ST. LAURENT, QUEBEC H4N-2L7	305 Decarie Boulevard	Tel. 514-748-8803
	CALGARY, ALBERTA T2H-0L1	448 42nd Avenue S.E.	Tel. 403-243-0971
		P.O. Box 5823, Stn. "A"	

WATCH US
GROW

IF YOU WANT TO BRANCH OUT INTO THE TV TUNER REPAIR BUSINESS,
WRITE TO THE BLOOMINGTON HEADQUARTERS ABOUT A FRANCHISE.

For More Details Circle (5) on Reply Card

www.americanradiohistory.com

(Continued from page 4)

Shades of "The Exorcist"! In Singapore, a witch doctor, an Indian mystic, and a Buddhist monk were called in to remove "evil spirits" from the General Electric TV-and-appliance plant, following mass hysteria affecting about 40 female employees. **Home Furnishings Daily** reported the plant had been forced to close three times before the "exorcism", but afterwards operated with full shifts.

Al Friedman, President of Chemtronics, says there is absolutely no reason for aerosol products to be banned at this time. The aerosol controversy was started by Drs. Rowland and Molina, two University of California scientists. One theory is that fluorocarbons used as aerosol propellants get into the earth's stratosphere where they destroy ozone. Since the ozone layer protects us from ultra-violet rays, a substantial decrease in the amount of ozone in the stratosphere could lead to an increase in the incidence of skin cancer. Other scientists have taken positions on the Rowland/Molina theory ranging from complete agreement to characterizing the ozone-depletion hypothesis as "utter nonsense." The only hard evidence has come from Drs. London and Kelley of the University of Colorado. Careful measurements made by these scientists indicate that from 1957 through 1970, the ozone layer over the Northern Hemisphere actually increased by 7%! According to Mr. Friedman, alternative propellants are available for most, but not all, electronic chemicals.

A powerful, short-pulse laser system that can measure within inches the distance between earth and an orbiting satellite has been delivered to the National Aeronautics and Space Administration by GTE Sylvania. Precise distance measurements will help scientists study motions of the crust of the earth that cause earthquakes, tidal waves, volcanic eruptions, mineral deposits, and mountain formations. To be installed at NASA's Goddard Space Flight Center, Greenbelt, Maryland, the laser will "range" from a satellite called LAGEOS (LAsER GEOdetic Satellite). LAGEOS, covered with laser reflectors, is scheduled for launch in March of 1976.

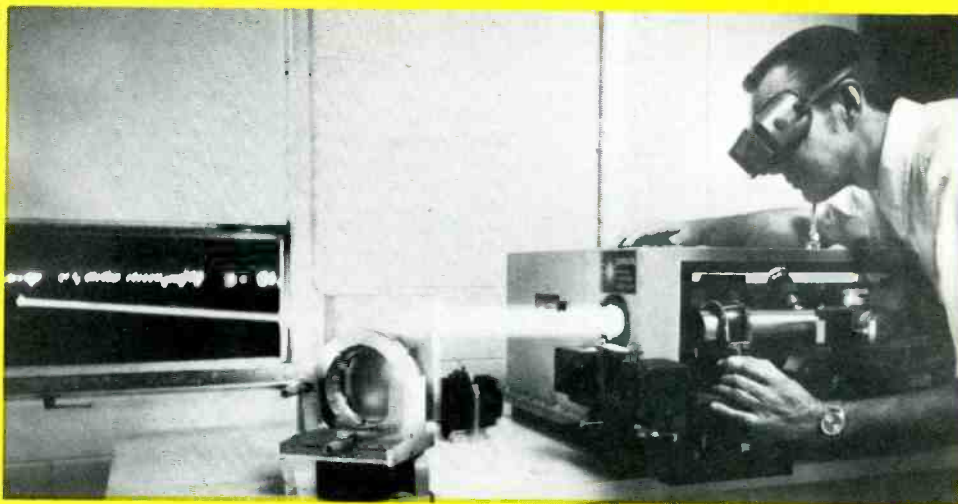

while the guy down the street complains about how tough alignments are... I do them!

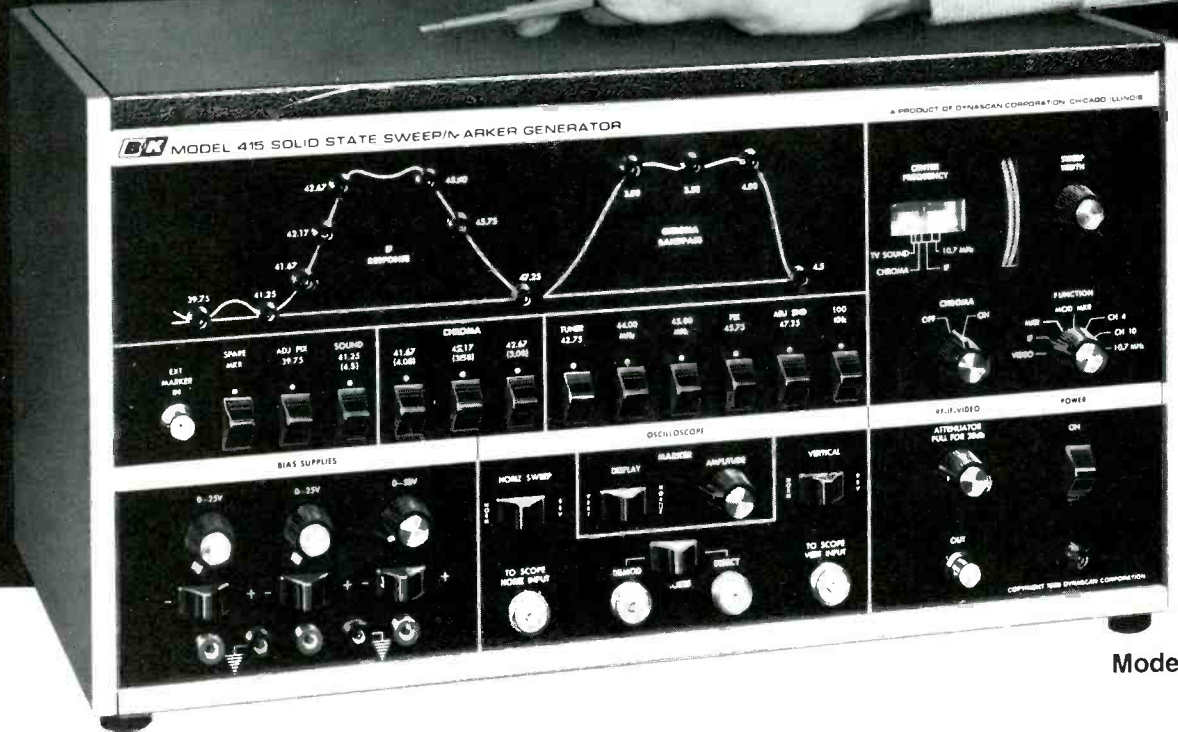

**Model 415
\$475**

I used to hook up a separate sweep generator, marker generator, marker adder and bias supply, hope that everything was properly calibrated and adjusted, and pray that the alignment would hold after I disconnected the cables draped all over the bench.

I didn't do it very often.

Now, in the time it used to take me just to set up, I can almost complete an alignment. And I'm confident the set will perform as well as it possibly can. My customers notice, too. That's the difference B&K's 415 Solid-State Sweep/Marker Generator made.

Setup is no problem. After I connect the 415's outputs to my scope (there's even low-frequency compensation to eliminate pattern errors), I connect its RF outputs (channel 4 or 10) to the antenna terminals or mixer test point, the direct probe to the video detector test point (or anywhere else after the video detector diode) and the demodulator probe to the bandpass amplifier output.

They're all clip-on connections, and the 415 comes with all the accessories I need. Once I've made the initial signal and bias hookups, there's nothing else to connect or reconnect. All intercabling changes and generator functions are controlled from the front panel. There's even a 15,750Hz filter to eliminate disabling

the set's horizontal output section.

Shaping the waveform is easy, because the 415 has 10 crystal-controlled IF markers, each of which lights up on the front-panel waveform diagram as it is used. Markers can be shown either vertically or horizontally on the scope trace. There's a 100kHz modulated marker that makes nulling the traps so easy it's almost automatic. And three low-impedance, reversible-polarity bias supplies—two, 0-25VDC; one, 0-50VDC.

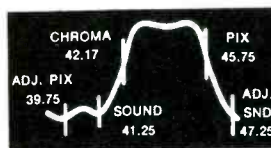

Vertical Markers

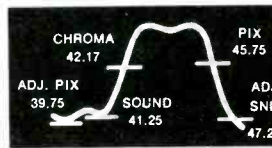

Markers Tilted Horizontally

Every step is easy to understand, too, thanks to the comprehensive manual.

Since I have nothing to sell but my time, I have to make the most profitable use of it I can. That's why I have a B&K 415.

In stock now at your local distributor or write Dynascan.

B&K PRODUCTS OF **DYNASCAN**

1801 W. Belle Plaine Ave. • Chicago, IL 60613 • Phone (312) 327-7270

Complete Line of Analog and Digital Multimeters, Oscilloscopes, Signal Generators, Semiconductor Testers, Power Supplies, Probes, Tube Testers and Substitution Boxes.

For More Details Circle (6) on Reply Card

Chassis—Admiral 3M10
PHOTOFACT—1504-1

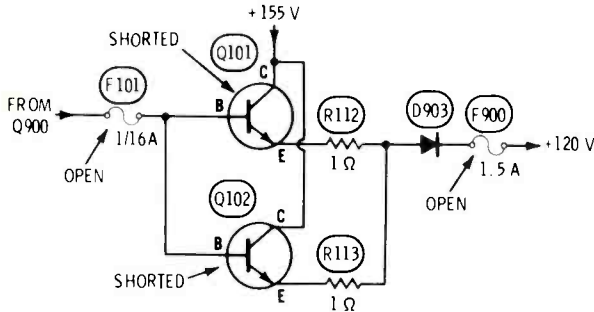

Symptom—Pulsating audio and raster because of the HV-shutdown circuit
Cure—Probably +120 is too high, check the components indicated.

Chassis—Admiral TK10
PHOTOFACT—1290-1

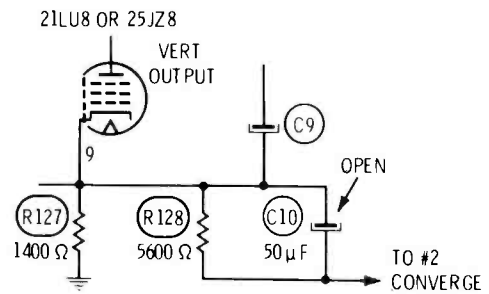

Symptom—Insufficient height
Cure—Check C10, and replace it if open.

Chassis—Admiral T15K10
PHOTOFACT—1392-1

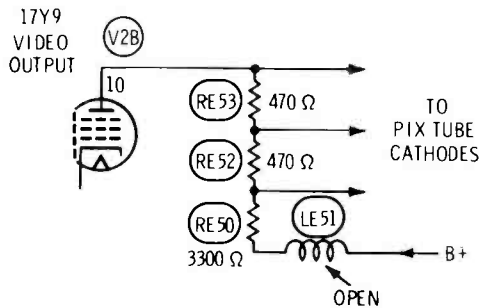

Symptom—Blooming or loss of HV, often intermittent
Cure—Check LE51, and replace it if open or intermittently open.

Chassis—Admiral M24
PHOTOFACT—1436-1

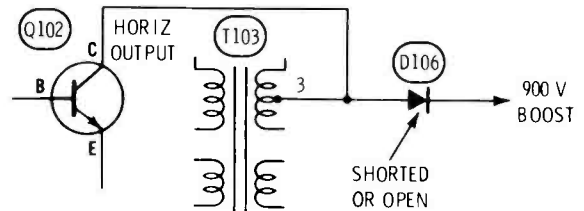

Symptom—Dark picture, and screen controls operate backwards
Cure—Check diode D106, and replace it if defective

Chassis—Admiral M24
PHOTOFACT—1436-1

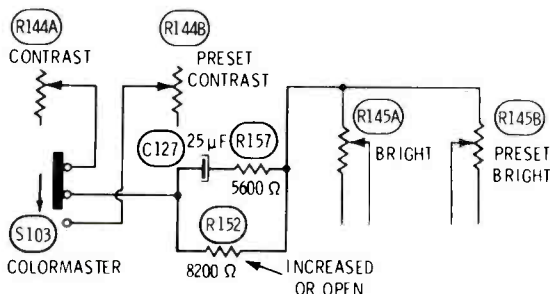

Symptom—Dark picture; screen controls work, but brightness limiter has little effect
Cure—Check R152 mounted with Color Master switch, and replace it if it has increased in resistance.

Chassis—Admiral G11 (and others)
PHOTOFACT—781-1

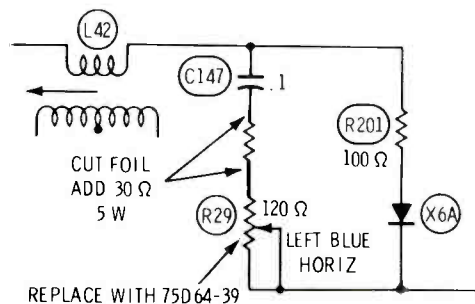

Symptom—Left-blue-horiz convergence control overheats
Cure—Cut the foil and add a 30-ohm 5-watt resistor as shown; replace R29 with a higher wattage, and replace L42 if it has been too hot.

reader's exchange

Needed: Manual or schematic for Hughes Memo-Scope Model 105A scope with dual-trace preamp 05-2 plug-in. Will buy, or copy and return.

Jim Tyrrell
4714 N.E. 112th Avenue
Portland, Oregon 97220

Needed: Schematic or manual for Philco UHF sweep generator model G8010. Will buy, or copy and return.

M. N. Yoder
6512 Truman Lane
Falls Church, Virginia 22043

Needed: Mallory GEM615 capacitors .05-600V and .25-200V.

Orlando Anselmi
R125 Second Street
Wyoming, Pa. 18644

For Sale or Trade: Transvision CRT tester (reactivator with high-voltage sparker), also Precision E400 sweep generator.

Al Crispo
159-30 90th Street
Howard Beach, N.Y. 11414

Needed: Rider's Manual #23 with index. Also, have Volumes 1-5 abridged, 6, 7, 8, 9, 10, 12, 13, 14, 15, 16 and 17 for sale or trade.

J. Allen Call
1876 East 2990 South
Salt Lake City, Utah 84106

Needed: Diagram for Model 520A regulated power supply by Harrison Labs.

Flo Sewell
Richie Electronics
P.O. Box N-7111
Nassau, N.P. Bahamas

Needed: New or used wire for wire recorder.

Andrew Pittek
222 Moyer Place
Pittsburg, Pa. 15210

Needed: Schematic and service information for a 4-tube Crusader cathedral-type radio, using 80, 47, 24 and 24A tubes. Dial is calibrated 0-to-100.

Lektro-Tek
4102 South Park Drive
Belleville, Illinois 62223

Needed: Schematic and instructions for Knight signal tracer Model KG690. Will buy, or copy and return.

John Grumbling
9 Woodcrest Drive
Oroville, California 95965

Needed: Complete service manual for Bell Imperial Model 1000B tuner-amplifier. Will buy or borrow.

Dick's TV & Electronics
P.O. Box 5
Mt. Airy, Maryland 21771

Needed: Schematic and instructions for Jerrold field-strength meter Model TMT. Will copy and return.

Mike Costello
40 Whiteway Street
St. John's Nfld.
Canada A1B 1K2

Needed: Delco power supply for auto radios; late-model VTVM or VOM; and all Rider TV Manuals after #13.

Arends Radio & TV
102 North Webster
Shenandoah, Iowa 51601

Needed: Manual and schematic for Jackson Model 640 test oscillator (100 KHz to 32 MHz). Will buy, or copy and return.

Steven P. Czaikowski
1026-B Brixton Court
Sterling, Virginia 22170

For Sale: Rider's radio manuals #6 through #17. Also, antique tubes, resistors and capacitors.

Goodwin Radio Shop
Rankin, Illinois 60960

Needed: Schematics for TV, radio, auto radio, etc. by a small, private, and **poor** 2-year college. Have no money, but offer a reasonable tax write-off. Please help some good students.

Charles Karafotias, CET
212 Linda Drive
Jensen Beach, Florida 33457

Needed: Tech manuals and schematics of WW-2 and Viet Nam vintage Signal Corps radio equipment.

Gail Dye
Route 1, Box 9
Benton, Illinois 62812

Needed: Manual for Hammarlund radio Model HQ-145. Will buy, or copy and return.

J. Carr
5440 South 8th Road
Arlington, Virginia 22204

For Sale: Rider's manuals #4, #7, #3, #9, #8, #11, #12 and #13 for \$5 each. Also, many older radio manuals. Write for list.

Richard Bogue
General Delivery
Sorento, Illinois 62086

Needed: Schematic and manual for experimental Hoffman color television built about 1948, and used as a demonstrator for first color broadcast in Kansas City, Missouri about 1949.

Ed Edwards, Jr.
c/o Garnier TV
Warsaw, Missouri 65355

Needed: Schematic and service data for a Lexington AM/FM stereo tuner with 8-track player, Model LE-74.

William Evans
121 Drew Road
Williamsburg, Virginia 23185

Needed: 7C6, 7B5 and 7Y4 tubes.
Dave Haman
Box 580, R.D. 6
Greensburg, Pa. 15601

(Continued on page 12)

FAST

COMPLETE SERVICE ON ALL MAKES OF TV TUNERS

Maximum Time In Shop 24 Hrs.

(WE SHIP C.O.D.)
YOU PAY SHIPPING
\$9.95

(Warranty: One Full Year)



Black & White or Color

VHF or UHF

UV Combo's \$16.50

Price includes all labor and parts except Tubes, Diodes & Transistors. If combo tuner needs only one unit repaired, disassemble and ship only defective unit. Otherwise there will be a charge for a combo tuner. When sending tuners for repair, remove mounting brackets, knobs, indicator dials, remote fine tuning arrangements and remote control drive units.

WE UNCONDITIONALLY GUARANTEE All Tuners FOR ONE FULL YEAR



All tuners are serviced by EXPERTLY TRAINED TECHNICIANS with years of experience in this specialized field. All tuners are ALIGNED TO MANUFACTURER'S SPECIFICATION on crystal controlled equipment and air checked on monitor before shipping to assure that tuner is operating properly.

GEM CITY TUNER SERVICE

Box 6G Dabel Station
1621 Mardon Drive
Dayton, Ohio 45420

troubleshootingtips

Send in your helpful tips—we pay!

Wrong hue action Zenith 16Z7C19 (Photofact 1014-3)

Every TV technician has a hidden fear of finding a receiver he can't fix. This case seemed to be one of those impossible repairs.

Adjustment of the hue control made little difference, so I dropped the tuner panel where the hue circuitry was located, and immediately found that R179 (1200 ohm) resistor was broken. Of course, I replaced the resistor, and turned on the set, confident the trouble was gone.

Unfortunately, the hues of color remained all wrong. With color bars, the blue bars were at the left, green in the center, and red at the right. I switched red and blue CRT grid wires, but green was still in the center.

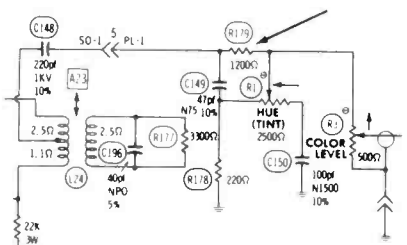
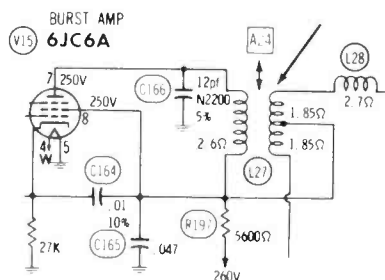

I decided to check demodulator phasing the scientific way by using my B&K 1460 triggered scope. Without dual-trace, it's necessary to use external sync input to keep the phase the same. I connected the wire from the external sync to pin 11 of the 6BV11 tube (output of the 3.58 MHz signal), and also attached the low-capacitance probe to the same point. Horizontal-sweep time

was set for .5 microsecond/CM and the X5 switch was pulled out to widen the trace. After proper locking, I centered one of the four cycles of 3.58 MHz on a vertical graticule line. Without changing the scope controls, I changed the LC probe to pin 2, and found a noticeable ¼ cycle difference of phase. That proved the false colors were **not** due to a wrong phase difference of the 3.58 MHz signals at the demodulators.

After spending considerable time checking in the area of the 3.58-MHz oscillator, I finally decided to try the color-locking adjustments. When I reset L27, the burst transformer, the colors pulled into place.

Evidently a technician who worked previously on the problem had merely misadjusted the burst transformer instead of finding the broken resistor. However, I don't understand why the color held in lock so well. Most sets will have soft color locking when the burst is that weak.

Max Goodstein
Flushing, New York

Excessive 6HV5 failures Zenith 14A9C50 chassis (Photofact 1097-3)

Jaggedness of any vertical lines in the picture (similar to those caused by arcs in the flyback) and excessive replacements of the 6HV5 HV regulator tube are two symptoms indicating the failure of R177, a 1000-ohm resistor connected between the screen grid of the 6HV5 and ground. Often these resistors are found to be burned or disintegrated, probably from shorts in a regulator tube previously used.

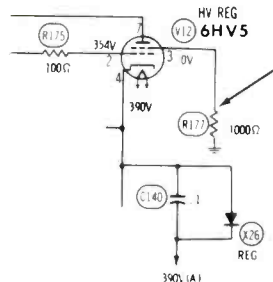

The resistor is wired to the regulator socket where it is easy to examine. I recommend you measure the resistance and visually test each one you get in the shop.

Charles B. Morgan
Norwood, New York

photofact[™]bulletin

PHOTOFACT BULLETIN lists new PHOTOFACT coverage issued during the last month for new TV chassis.

ADMIRAL	
Chassis T5R3-1A/-2A, T6R2-1A/-2A	1514-1
BRADFORD	
1171E45 (WTG-80630),	
1171K35 (WTG-80432)	1513-1
1071G45 (WTG-90969)	1514-2
BROADMOOR	
2519	1477-1
CATALINA	
122-5346A	1512-1
CHANNEL MASTER	
6157A, 6158A, 6159A, 6160A	1490-1
CORONADO	
TV22-1026A	1515-1
GENERAL ELECTRIC	
Chassis XA	1491-2
Chassis 17YA	1495-1
HITACHI	
CA-550, CE-700, CR-350, CT-900	1487-2
JC PENNEY	
2124 (855-2323)	1477-2
4849A	1478-1
1618 (855-2283), 1721 (855-2325)	1508-2
JVC	
7130	1479-2
K MART	
SKC2520, SKC2520-1, SKC2530, SKC2530-1,	
SKC2540, SKC2540-1	1480-1
MAGNAVOX	
Chassis T981, T982, T987 (Series)	1509-1
MOTOROLA	
Chassis AH/AL/H/J/L/LJ19TS-931	1479-3
MOTOROLA/QUASAR	
Chassis C/D/E/YC/YD/YE/12TS-476T	1493-2
PANASONIC	
AN-249A (B)	1480-2
PHILCO-FORD	
Chassis 5BS41, 5BS41/C	1480-3
PHILCO-FORD	
Chassis 5CS51/52/61/61-C/62/62-C/63,	
5CY81/82/93	1487-3
SANYO	
Chassis TM-36000, TM-36001, TM-38000	1509-2
Chassis SA-53000, SA-54000, SA-63000,	
TB-75000, TB-75001	1510-1
SEARS	
528.41104400/5400, 528.41671400	1467-2
562.51430300	1472-3
528.40591400 thru 528.40591419	1510-2
SONY	
TV-960	1466-2
SPECTRICON	
B19SS175	1489-1
TOSHIBA	
Chassis TAC-9830, TAC-9840	1471-2
Chassis TAB-9310, TAB-9320	1508-3
TRAV-LER	
Chassis TL6-1A/-2A, T1L6-1A/-2A	1507-2
TRUETONE	
GEC3412B-57 (2DC3412B),	
GEC3415B-57 (2DC3415B)	1494-3
WEG2669A-67 (2DC2669)	1495-2
WARDS AIRLINE	
GAI-16425A/55A, GAI-17145A/45B,	
GAI-17225A/25B/25C,55A,55B/55C,	
GAI-17425A/25B/45A/55A/55C,	
GAI-17825A/25B/25C/35A/35B/45A/45B/	
55A/55B	1514-3
WARDS AIRLINE	
GEN-11765A, GEN-11965A	1468-3
GEN-12985A/B	1469-2
ZENITH	
Chassis 9FB1X	1489-3
Chassis 12FB12X	1490-2
Chassis 16FB22X	1488-2
ZENITH	
Chassis 17FC35/45, 19FC45/45Z	1466-3
Chassis 23DC14	1505-3

the bright one

new phosphor picture tube
with twice the brightness

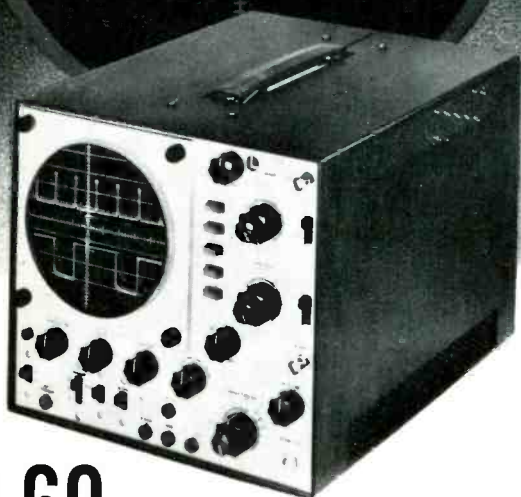
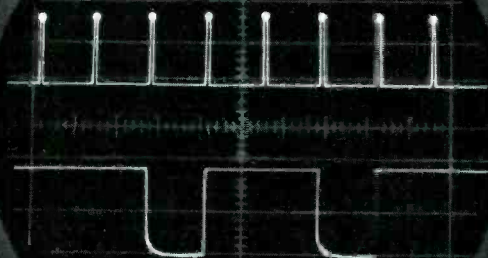

TO-60 automatic dual-trace triggered-sweep oscilloscope

P-31 phosphor CRT has double the brightness for bright displays even in high speed dual-trace modes. Bandwidth: DC to 15 mhz. Unique features for the industry's greatest value are: • Automatic Triggering • Automatic Astigmatism • Automatic Horizontal Sweep • Automatic Horiz/Vert. TV Triggering provides positive display on composite video signals. Vertical sensitivity: .01 volts/cm to 20 volts/cm in 1-2.5 step sequence. Horizontal Sweep Speeds: .2 sec/cm to .5 μ sec/cm in 1-2.5 step sequence. Has 5X magnifier at all sweep speeds. External Horiz. Amp. Bandwidth: DC to .5 mhz; Sensitivity: .5 volts/cm. Calibrated Test Signal: 1 volt P-P square wave. Power: 105-125 volts, 60 cycles, 65 watts

Model TO-60 Less Probes. Net \$489.50

TO-55 automatic single-trace triggered sweep oscilloscope. Features same as TO-60 except Vert. Bandwidth is DC to 10 mhz.

Model TO-55 Less Probes. Net \$379.50

For the "bright one," see your distributor, or write:



LECTROTECH, INC.

5810 N. Western Avenue, Chicago, Illinois 60659
Area (312) 769-6262

For More Details Circle (7) on Reply Card

(Continued from page 9)

Needed: Eico 666 or 667 tube tester, and wide-band Mercury or Sencore scope: reasonable prices.

Ken Miller
10027 Calvin Street
Pittsburgh, Pennsylvania 15235

Needed: Feiler Engineering stethoscope, Model TS-2; Superior Instruments signal tracer, Model CA-11; Supreme Instruments Model 504 and audiolyzer Model 562. State price and condition.

S. B. Hilty
Makaha Valley Towers #1416
Waianae, Hawaii 96792

Swap: Hickok dynamic transistor tester, Model 870, in good condition, for color bar generator or other TV test equipment.

Kenneth Miller
10027 Calvin Street
Pittsburgh, Pennsylvania 15235

For Sale: 150 older-type Sylvania radio and TV tubes, unused. Send for list.

Lenke TV
1471 San Marcos Drive
Hemet, California 92343

Needed: Schematic for Model 156 Genometer made by Accurate Instrument Company. Will buy, or copy and return.

N. G. Just
1926 Nocturne Drive
Valley Station, Kentucky 40272

Needed: Schematic and operating manuals for B&K 960 Radio Analyst and Eico Model 944 transformer tester. Will buy, or copy and return.

Warren K. Perry
5902 Palo Alto Drive
Memphis, Tennessee 38138

Needed: Schematic and calibration information for Vomax VTVM Model 900 made by McMurdo Silver Company.

Frank A. Bertin
1047 Marion Drive
Glendale, California 91205

Needed: Remote control P/N 80-7055-8A04 for Motorola Quasar. Quote price.

Niles Van R. Johnson
409 Colbert Avenue
Pensacola, Florida 32507

Needed: Schematic and service data for Fuji Electric portable TV, Model TF2-23R. Will pay for use, or copy and return.

Jerry A. Chambers
127 Morris Drive
Dover, Delaware 19901

Swap/Sell: Tektronix RM-15 oscilloscope (rack-mounted type 515A), DC-15 MHz, delayed sweep, 5X mag. Also have pulse generator Model UPM-15, 50 Hz—10 KHz, sync pulse plus two output pulses; amplitude, width, and delay adjustable, can be triggered externally.

Needed: Good DMM, B&K sweep/marker generator, B&K Chanalyst.

J. E. Ryan
4625 Tumbleweed
El Paso, Texas 79924

For Sale or Trade: Cartrivision video tape recorder. Make offer, or write for more information.

Art Steidl
10916 Arroyo Drive
Whittier, California 90604

Needed: Manufacturer's address, or address of anyone providing parts, for Wilkinson line locator, Model WH-4.

B. G. Dean
Box 293
Dyersburg, Tennessee 38024

Needed: Schematic or manual for Laboratory For Electronic oscilloscope, Model 401. State your price.

Hoy D. Brannon
3909 Moller Road
Indianapolis, Indiana 46254

Needed: Transistor for a General Electric digital clock radio, Model C4315A. Numbers on transistor are 7672 and 7223.

J. Mehalko
324 Fourth Street
Blakely Olyphant, Pennsylvania 18447

Needed: Schematics for Blaupunkt "Ballett" AM/FM radio, Model 2500USA and "Candle" miniature TV, Model MT510A.

William Bernstein
215 Middleneck Road, Building 7
Great Neck, New York 11021

Needed: Deflection board part number X-40043-49-1 for Sony TV, Model 4-203UW. State condition and price.

Morton's TV
510 C
Cache, Oklahoma 73527

Needed: Picture tube number 280GB4 for Sears TV Model 6104; one good HV transformer for Model GR-53A, series 506-6638 Heath color TV; also schematic and alignment data for an RCA 9K29 chassis.

Sherwood T. Smith
RR #4, Mile Hill Road
Rockville, Connecticut 06066

Needed: 8AV11 tube for Aiwa TV, Model 11T04.

Robert L. Baker
1011 Westwood Drive
Goshen, Indiana 46526

For Sale: Eico Model 460 oscilloscope with probes; Eico dynamic tube and transistor checker, Model 667; and Sencore color generator, Model CG141. Excellent condition. Will accept best offer.

Jim Staker
8102 East Windsor Avenue
Scottsdale, Arizona 85257

Needed: Used test equipment.

Paulmer Williams
106 South Jefferson Street
Lewisburg, West Virginia 24901

Needed: Service literature for Commodore TV, serial number 2071, chassis number 2015.

Chuck Anderson
7303 Oliver Smith Drive
Des Moines, Iowa 50322

Wanted: Used picture tube rebuilding equipment, not necessarily in working condition. State type, condition, and price.

Robert L. Nelson
3602 Mount Aclare
San Diego, California 92111

Needed: Service manual for an Amphenol Model 840 signal commander field strength meter.

Al Amely
Route 1 Box 201-D
Beaufort, South Carolina 29902

The Money Generator



A BETTER APPROACH TO TV ANALYZING Pat. Pend.

The ATC-10 is different from other color bar pattern generators. It's like a portable test lab with the versatility to perform the most commonly used functions of an analyst and a substitute tuner. It's a **time saver** for both in-home and on-the-bench servicing. That's why we've nicknamed it the **MONEY GENERATOR**. Since it takes more than a few words to describe the ATC-10's many unique features, we'd like to send you our big 4 page illustrated brochure.

This brochure tells you about the ATC-10's unique patterns which include RED RASTER, 3.58 MONITOR, GRAY QUAD, and HATCHDOTS. It also describes some unusual test capabilities such as: • A full range of crystal controlled RF, IF, and video injection signals • Receiver sensitivity and dynamic range checks using the calibrated RF output control • Fast accurate purity and 3.58 oscillator checks with no need to disable guns or short test point(s) • Extra clear oscilloscope and vector patterns • In-Home receiver bandpass checks at 60 Hz, 1.78 MHz, and 3.56 MHz • Complete convergence series using a single composite pattern • (all of these and many more for only \$299.95.)

The brochure is free, but, if you'd like **still more information** on the operation of the ATC-10, you can obtain a copy of the 2 volume (home-shop) owner's manual. Just include \$1.00 for postage and handling. **Act now** and evaluate for yourself the many ways the ATC-10 can be a real **MONEY GENERATOR** for you.

Mail Request To:
AMERICAN TECHNOLOGY CORP.
225 Main, Dept. 1A, Canon City, CO. 81212

Name _____
Address _____
City _____
State _____ Zip _____

For More Details Circle (8) on Reply Card

MICROWAVE OVENS...

Theory and Servicing



By Wayne Wenzlaff

An estimated two million microwave ovens now are in use, and more than a million should be sold this year. Servicing microwave ovens can be a profitable sideline for you. Although the circuits are simple, a logical procedure for troubleshooting is necessary to prevent damage to the magnetron tube, and to minimize safety hazards.



Table-top microwave ovens can be placed almost anywhere in the kitchen, because of their small sizes and the minimum amounts of external heat. (Courtesy of Admiral Corporation).

Ever since the first caveman discovered that his food tasted better after it was held over a fire for a time, mankind has been looking for quicker and better ways to cook food. At present, many people are enthusiastic about microwave cooking, believing it to be the best of all methods.

However, the first uses for microwave energy had nothing in common with food preparation.

From Battlefield To Kitchen

Pulses of microwave frequency bounce from some objects and return to the point of origin, but ordinary radio waves merely travel through the materials without being reflected. This important discovery was made in the late 1930's. Time is required for the microwave signal to reach the object and bounce back to the source. The distance from antenna to reflecting object can be calculated from the speed of radio waves versus half of the elapsed time. A method was developed for measuring these small units of time by displaying the original pulse and the echo pulse along the same sweep of a cathode-ray tube, with the screen calibrated for distance. Thus, Radio Detection And Ranging (RADAR) was born.

During World War II, hundred of millions of dollars were spent for

the development of better microwave tubes, including amplatron, platinatron, magnetron, and klystron types. To illustrate the value of microwave equipment to the military effort, radar has been rated as more important than the atomic bomb in winning the war for the Allies.

With the end of the war in 1945, the need was to "beat the swords into plowshares," and some manufacturers began searching for new uses for microwave equipment. A candy bar melted accidentally is supposed to have alerted an engineer to the possibility of heating food with microwaves. However, others must have noticed heat when they stood in front of a radar antenna. In any event, the search started for ways of cooking food with microwaves. Raytheon developed an experimental oven in 1945, sold a few huge and costly ovens to restaurants in 1947, and during 1954 offered for sale the first practical home-kitchen microwave ovens. Later, Raytheon acquired Amana, and transferred the trade-name "Radarange" to them. Probably a dozen manufacturers today market microwave ovens.

Microwave Characteristics

Microwaves are similar in some ways to the RF carriers from radio and TV stations; all are classified

as "electromagnetic energy." However, microwaves are very high in frequency (short wavelength). By definition, microwaves are not less than one millimeter or more than one meter in wavelength.

A microwave oven can be compared to a simple radio transmitter without an antenna; either can emit some RF radiation. Therefore, the FCC regulates the frequency, and the U.S. Bureau of Radiological Health sets the performance standards regarding safety. Three frequency bands are set aside pri-

Fig. 1 The electrons inside a magnetron tube move in circles. (A) In a normal diode, the electrons travel in a straight line from the center cathode to the plate, whenever the plate is positive. In magnetrons, the electrons form in "spokes" which rotate in a circle, the form and speed being regulated by the shape of the resonant chambers between the vanes, and by the magnetic field (B) Powerful magnets with their poles above and below the elements of the magnetron help move the electrons in a circle (C).

marily for microwave ovens. They are 915 MHz, 2450 MHz, and 5800 MHz. Police radar operates at about 2250 MHz, and telephone companies use 5000 MHz, so it's easy to see why the oven frequencies must be accurate and stable.

Most ovens operate at 2450 MHz, because less energy is required to cook food at that frequency than at 5800 MHz, and it doesn't heat glass and plastics so much as 915 MHz does. The wavelength of 2450 MHz is .1224 meters or about 4-3/4 inches.

Microwaves compared

Microwaves can be generated, transmitted, reflected, and absorbed. Just as light is reflected from a mirror, microwaves are reflected by most metals. Both light and microwaves can pass through glass. However, dark glass blocks light, but allows microwaves to pass through freely. Water is nearly transparent to light, but it absorbs microwaves.

Selective absorption

The characteristic of microwaves to be either absorbed or not according to the material makes possible an oven with walls that remain cool while the food inside is cooking. If the bowls or containers of food get hot, it's because of heat from the food inside, not because

they absorb energy from the microwaves. However, metal dishes shield the microwaves from food, and should not be used.

How Magnetrons Work

Although magnetrons are tubes and do oscillate, they have little other similarity to the tubes we know about. For example, a normal diode (Figure 1A) conducts when the anode is positive relative to the cathode, with the electrons going straight from the cathode in the center to the nearest wall of the plate.

Magnetrons operate by a kind of cavity resonance and an external magnetic field. Blow across the mouth of an empty soft drink bottle in a certain way and you can generate an audio tone. The puffs of air excite the air in the cavity (Helmholtz Resonator). Where are the input and output coupled together to make it oscillate?

In a similar way, clouds of electrons in a magnetron move past tuned vanes, producing a signal of a frequency determined by the physical shape and location of the resonating vanes. A magnetic field moves the clouds of electrons in a circle around the cathode.

Refer to Figure 1B. Instead of the electrons leaving the cathode and moving straight out to the anode (because of the pull of the

anode voltage), they start moving in a circle, shoved by a magnet with one pole above the tube and one below (Figure 1C). Remember that the attraction or repulsion of a magnet is at **right angles** to the field. As the electrons pass the vanes, a microwave signal is induced in the metallic resonators.

After the action builds up, the electrons form in groups something like spokes and rotate much as an armature does in an electric motor. There are half as many spokes as there are vanes, and they rotate at synchronous speed so as to be always approaching (and attracted by) a negative resonator vane.

A coupling loop inside one resonator couples some of the energy outside for use in heating food. The resonators are inter-coupled tightly, so the load is equally distributed between all the resonators.

Conditions to avoid

If the magnetron is operated without a load (no food in the oven), many of the electrons inside the oven space return to the cathode of the magnetron. This can increase the temperature of the filament, perhaps causing it to burn open, or have reduced electron emission so that full power is not possible.

Excessive loads on the magnetron

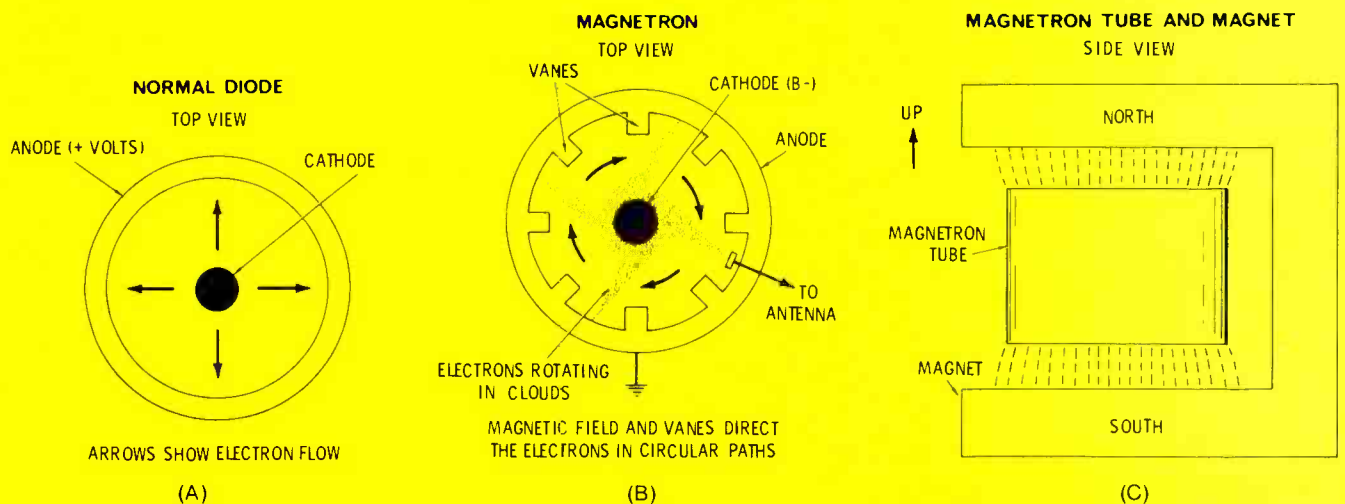

Let me show you the pricing system that makes it easier for shop owners to make a profit.



tv & radio tech's guide to pricing

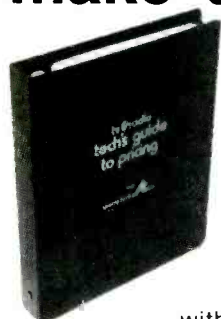

This system is proving itself in thousands of shops from coast to coast and Canada. It allows you to price your work profitably

with conviction... A new dimension in pricing...

keeps a true and proper balance between cost and work performed with computer like accuracy.

The original 6"x9" page size, hard cover, steel ring-bound issue for shop use remains available. It's the same system used in the Satellite described below. \$18.95 postage paid.

John C. Sperry John C. Sperry

Now, the system goes pocket-sized

The advantages of using the pocket-sized pricing guide is obvious (even fits a shirt pocket) fast-tab indexing to 19 major repair categories... your own print out and guide to reliable pricing. It's all you'll ever need for fast errorless pricing in the field, bench, or over the counter... you can bank on it... \$16.95 postage paid, instruction manual included.

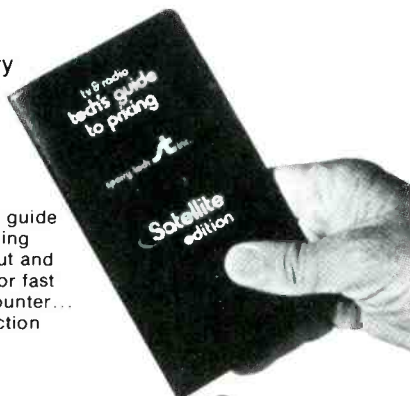

And, parts pricing right out of the same pocket!

Hundreds of man hours are lost every year hunting down various parts prices during billing time that can be drastically recovered by the parts Satellite. Over 3500 fast moving parts are cataloged and up-dated periodically. In ordering a parts Satellite, all you do is fill out and send in the coupon below. We then send you a three-page work sheet on which you show us the mark-up you desire for different parts categories... a computer printout is then made with your retail parts prices tabulated. It is then reduced and bound into a compact parts catalog. The initial programming and set up charge is \$75.00 plus \$10.00 for each catalog.

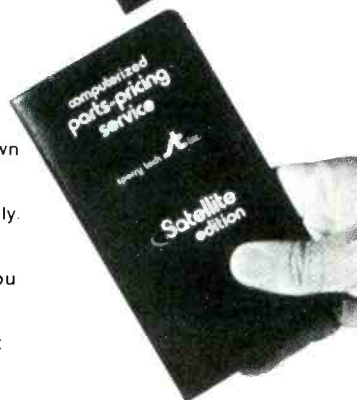

sperry tech inc. P.O. Box 5234 Lincoln, Nebraska 68505

- My check or money order enclosed for _____ copies of large (6"x9") pricing manual.
- My check or money order enclosed for _____ copies of the Labor Satellite.
- My check or money order enclosed for _____ copies of the Parts Pricing service.
- More information on all three.

Name _____

Company _____

Address _____

City _____ State _____ Zip _____

Ne. residents add City and State taxes U.S. Currency equivalent.

should be avoided. In normal operation, this is no problem. But don't attempt to operate an oven with the wrong magnetron, or one with the waveguides damaged or modified.

Operating under conditions of excessive anode current, wrong load, or with reduced cathode emission can result in "moding." Moding causes dissipation of the rotating clouds of electrons, a loss of oscillation, or a change to a wrong frequency. Anode current drops drastically, and the oven does not heat to the full rated wattage.

Magnetron Circuitry

Circuitry of the magnetron tube hardly could be more simple, for it consists only of the tube, magnet, waveguides to direct the energy to the cooking area, and the power supply (Figure 2).

By contrast, the power and control wiring is quite extensive. A typical manufacturer's schematic shows an oven light with switch, a buzzer and switch, timer, dial lamp, stirrer motor, blower motor, defrost motor, and several safety door interlock switches.

Power supply

Requirements of a power supply for a magnetron are quite different than they are for other tubes. A magnetron will operate on raw AC power, but the tube draws current only during the top 15% of the waveform, thus giving an unfavorable ratio between peak and RMS current. Conventional well-filtered DC power supplies probably enable the magnetron to work at its best, although they are costly, bulky, and heavy. Also, they are more of a shock hazard to a technician, and cause more damage in case of a severe overload.

A workable compromise is to use a single rectifier in a peak-reading circuit, but with a small capacitor to limit short-circuit current. Usually, the filter capacitor is 1 microfarad, or smaller.

The circuit of Figure 2 shows that SR1 solid-state rectifier is connected in a shunt circuit, which produces about -4000 volts with high ripple. In fact, the output is

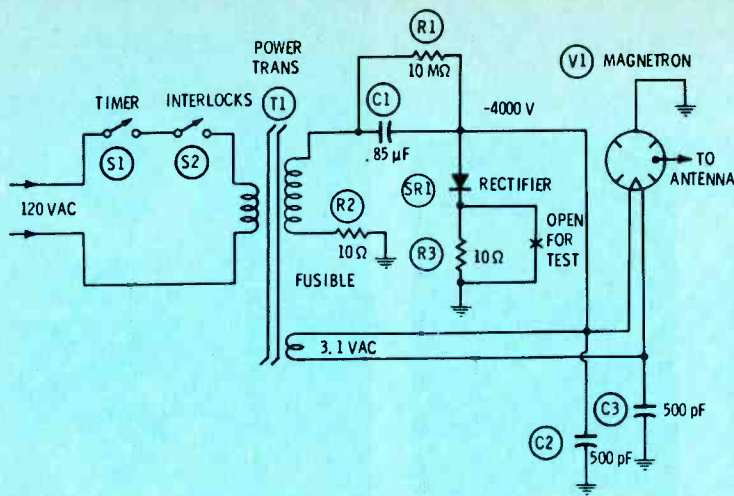

Fig. 2 Magnetrons do not require any tuned circuits; in fact, they need only a power supply, cooling system, and an output electrode. Most power supplies have a large amount of ripple. This one is a half-wave shunt type, operating from a ferroresonant saturable transformer, providing AC regulation.

an AC waveform that's clamped to ground at the positive tips by the conduction of the diode.

Output of the negative DC supply goes to the filament/heater wires, probably because the anode circuit can be grounded, making the insulation requirements easier. (Of course, the anode is positive relative to the heaters.)

Two 10-ohm resistors are included to permit easy measurements of the current. The DC voltage drop across R2 indicates total current of the rectifier and magnetron, while the rectifier current alone goes through R3.

Most microwave ovens have a ferroresonant power transformer for AC regulation to make the cooking times consistent regardless of line-voltage variations. In some cases, the transformer windings and the filter capacitor form a tuned circuit. Therefore, you should not replace the capacitor with one of a different value.

Radarange Description

The machine of Figure 3 strongly resembles a table-model TV receiver, even seeming to have a picture tube on the left and VHF and UHF knobs at the right. But it is a Model RR-4D Amana Radarange oven.

Most of the circuitry and electronic components are located to the right of the oven cavity. The

door has perforated metal (Figure 4), so a person can look inside while the oven is cooking. However, glass covers both sides, to prevent children from poking in hair pins or pencil tips.

This model has two timers (Figure 5). One is calibrated in 15-second segments up to 5 minutes, and the other in 1-minute units up to 30 minutes. In addition, there is a switch and timer for Automatic Defrost.

For servicing, the entire right side panel comes off. On the bottom edge is a label warning of a cancelled warranty, if anyone except an authorized serviceman breaks the seal. And underneath the label is a rivet, which must be chiseled off. After several screws are taken out, the side can be removed easily, exposing much of the wiring and most of the components (Figure 6).

At the lower center is the large power transformer, and just to the right and higher is the magnetron tube. The end where the two heater leads enter the magnetron are at the bottom of the assembly. A plastic safety cup covers the terminals where the transformer wires are attached. If this cup is removed, two spring clips ground the terminals.

The top of the magnetron has a metal rod (the antenna) enclosed by the glass of the tube (Figure 7).

This is where the microwaves come out inside a waveguide (metal duct) which channels the waves to the top of the oven cavity.

Without any more components, the microwave energy inside the oven would be concentrated at "hot spots," giving uneven cooking. To prevent the hot spots, a "stirrer" is provided. The stirrer is only a simple metal fan blade (Figure 8), which revolves slowly, making the radiation path more random.

Some brands and models have a separate small motor to drive the stirrer blades. The Amana Model RR-4D routes some of the air from the blower that cools the magnetron through the oven cavity to move the stirrer, and to remove any vapors from the cooking. The air is drawn in through the cabinet bottom, comes up through the magnetron, in and out of the oven, through the blower, and is exhausted from a grill above the control panel.

Also easy to remove is a metal plate holding the power transformer, filter capacitor, and a board with the HV rectifier and fusible resistor, as shown in Figure 9. **Use a screwdriver blade to short across the terminals of the capacitor**, even though a 10-megohm resistor is there to bleed the voltage.

Interlock switches on either side of the door (Figure 10) open the power circuit to the transformer any time the door is opened.

Suppose a roast had been cooking for twenty minutes, and the housewife decided to baste it. If she opened the door without first pressing the "Stop" button, the interlock switches would open the circuit, and the mechanism would push out the "Start" button, eliminating all power from the magnetron and stopping the timer. Then after the door was closed, she would push the "Start" button, applying power to the magnetron, and the timer would start to run again, completing the time that had been set originally.

Servicing Microwave Ovens

Microwave ovens are simple to service. However, you should use a logical method of testing. This

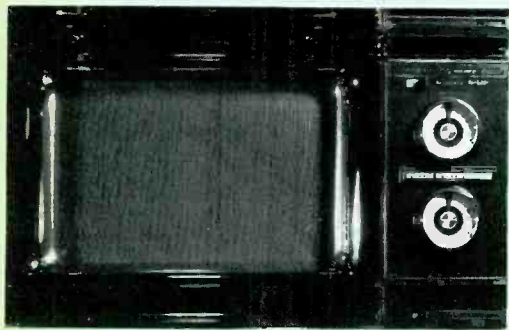

Fig. 3 This is the front view of one model of Radarange from Amana.

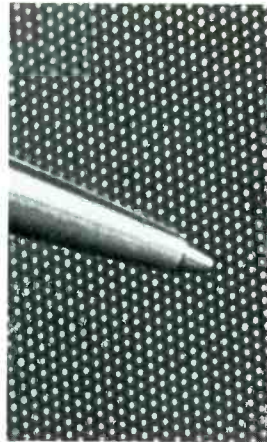

Fig. 4 A ball-point pen provides a size comparison for the perforations in the door panel that allows you to see through the door, but does not permit the microwaves to get out.

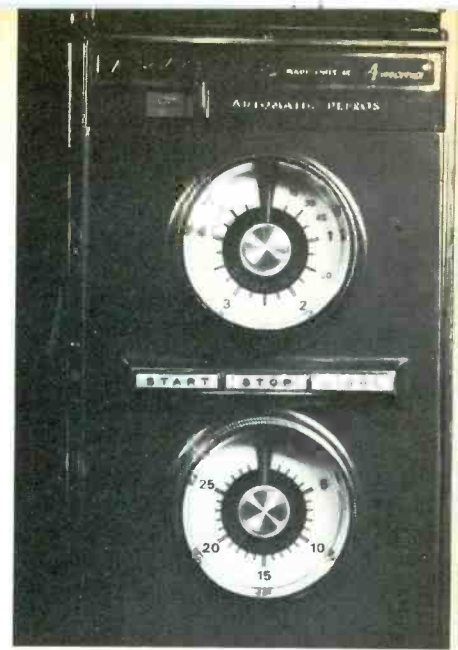

Fig. 5 At the top of the Amana front control panel is an automatic-defrost switch. Below that are the two timers, one for a maximum of 5 minutes, and the other giving up to 30 minutes. In between the timers are the three pushbutton switches for "Start", "Stop", and oven "Light".

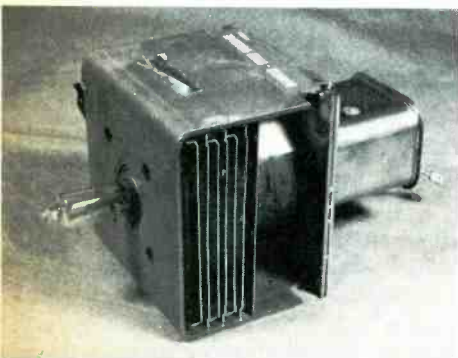

Fig. 7 Here's the way the magnetron and magnet assembly looks after it is removed. The output rod is at the left, and the filament leads at the right. When in operation, the output section is at the top.

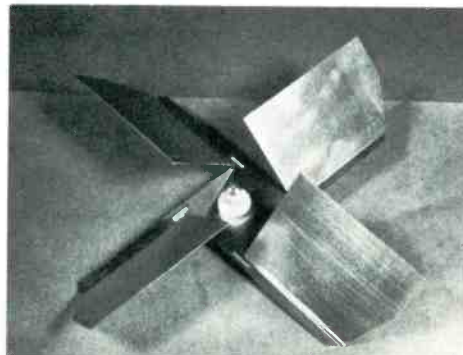

Fig. 8 In this model, the stirrer blades are not rotated by a motor, but are moved slowly by the air that cools the magnetron tube.

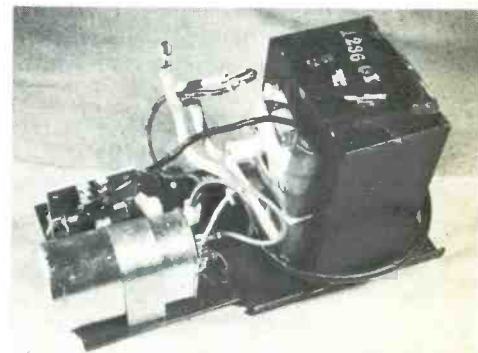

Fig. 9 All the power-supply components are mounted on a plate. At the left above is a small board with the HV rectifier and fusible resistor, below that is the .05 microfarad filter with its bleeder, and the large power transformer is at the right.

saves time, prevents damage to the magnetron tube, and protects you from severe shocks. Most of the tests can and should be done with the power off.

Heat test

For a quick test for heating ability, place a styrofoam cup filled with water in the oven, and set the timer for 1-1/2 minutes. The oven

should heat the water to about 180° during that time. No increase of water temperature means the oven is not heating at all, and an intermediate rise of temperature probably indicates weak output from the magnetron.

No heating

If the heat test gave no increase of water temperature, unplug the

power cable and connect an ohmmeter across the two active prongs. Use the low resistance range. Close the oven door and set a timer. The ohmmeter now should read nearly zero ohms (the timer and stirrer motors will give a reading, but it should be much higher).

A higher reading probably means an open timer switch, open door-interlock switch, open primary of

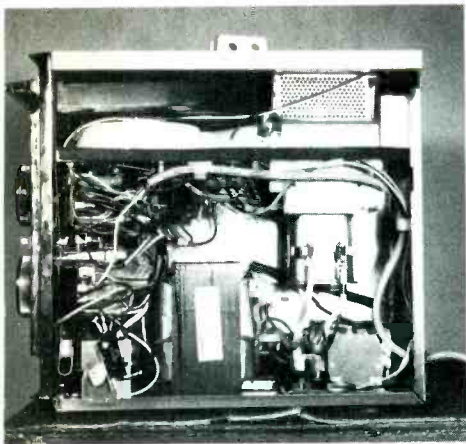

Fig. 6 The right side panel can be removed to expose most of the wiring and components. At the left below is the defrost timer, above it is the 30-minute timer, 3 switches, 5-minute timer, blower motor, and the blower duct. In the center is the power transformer. The rectifier and filter capacitor are at the lower right, with the magnetron tube above them, feeding the waveguide that directs the microwave energy to the oven cavity.

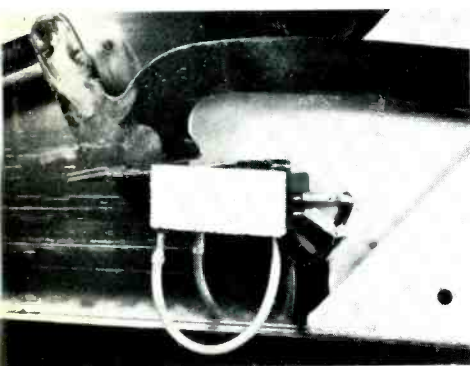

Fig. 10 One snap-action interlock switch is mounted on each side of the oven door. Opening the door removes the AC power from the magnetron.

the power transformer, or an open lug or connector. These last possibilities are rare. A few ohmmeter tests should locate the open. In the remote chance of an open winding of the power transformer, the primary should be disconnected and tested alone, to prevent false readings from the other circuits.

If the continuity is normal from power plug through the power

transformer, then suspicion should be directed toward the filter capacitor, HV rectifier, and magnetron tube. You can measure the high voltage at the filament/heater terminals of the magnetron, by using the kind of probe intended for testing up to 5 KV of CRT focus voltage. **Use extreme care to avoid shocks.**

Let's say the high voltage was almost zero. Unplug the power cable, discharge the filter capacitor with a screwdriver blade, and then feel of the HV rectifier and filter for any sign of excessive heat. The hot one probably is bad.

However, if the HV is normal (usually -4000 volts), the magnetron is the final suspect. There are no practical tests for a magnetron, except replacement.

Weak heating

In case the oven heats some, but not enough, the DC high voltage and the magnetron tube are the two suspects. Of course, we assume you have checked for damage (perhaps being dropped) of the oven that has distorted the waveguides or stopped the stirrer motion.

Power test

If the oven heats, but you are not certain it has full-power output, measure the AC input power with a wattmeter. Compare the reading with the manufacturer's specification. This is the best and safest test for full-power output.

Incidentally, you can assure microwave users that the food is **not** cooked from the inside out, contrary to popular belief. In most cases, the food cooks the same all the way through. Although, the outer parts slightly shield the waves from the inner ones, making a thick roast, for example, just a little less well-done in the center.

Radiation

Late-model microwave ovens are constructed very well to prevent any leakage of microwave power. Many employ carbon-impregnated door gaskets and special doors, so the chances of leakage are very remote.

Always use a damp cloth to clean around the door and the seals,

removing any food crumbs or other foreign material that might keep the door from sealing correctly. Make certain that power for the magnetron is removed when the door is opened.

If a customer asks about radiation, assure her or him that the power is radio-frequency, and **NOT** radioactivity, or X-rays, or atomic radiation. With the possible exception of the eyes, no body tissues can be damaged by microwaves without abnormal heat being there to serve as a warning that something is wrong.

Remarks

Because of the electronic circuits and components used in microwave ovens, it's most natural for TV technicians to repair them. They already have the knowledge and test equipment, and lack only the experience. We hope these facts will help you get started in this new field. □

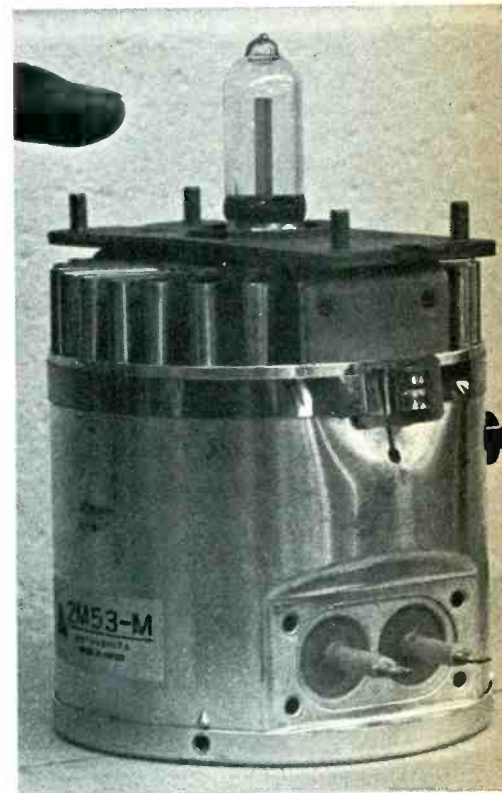

This magnetron assembly is made by Matsushita. Notice the ribs for heat dissipation. A finger points to the output "antenna."

SERVICING RCA XL-100



Part 3/By Gill Grieshaber

Probably the RCA horizontal-sweep stages using SCR's are the least understood of any solid-state circuit. We intend to clarify the operation of those sections. However, it's necessary first to take up the MAH001A horizontal-oscillator module, and the over-voltage protection. Then, following some new information about the old subject of ringing, the complex voltages and currents controlling the trace and retrace ringing actions will be covered in depth.

Circuits of the MAH001A horizontal-oscillator module (Figure 1) in RCA CTC58 chassis are similar in many ways to some horizontal circuits in tube-powered color TV's. One exception is the sawtooth shaper stage. Locations of the module and the over-voltage-protection transistor are shown in Figure 2.

MAH001A Horizontal Module

Horizontal sync of about 30-volts PP enters the module at terminal #10. The amplitude is reduced by R1 and R2 (see Figure 3), and the waveform is differentiated by C1 and R3, at the base of Q1, the phase-splitting transistor. Q1 has no forward bias except for the 17-volt PP positive-going pulses of the sync. This combination does not produce much base current (proved by the zero DC reading at the base), and the stage provides little

gain, partially because it has two polarities of output signal.

A non-inverted output signal comes from the emitter of Q1. R6 raises the impedance of the emitter circuit as seen from C3, which couples the sync pulses to the anode of CR2. From the collector of Q1, the inverted sync pulses are coupled through C2 to the cathode of CR1. One more signal is needed to make this into a phase detector: sawteeth from the horizontal sweep circuit must be present at the anode of CR1 and the cathode of CR2.

Sawtooth shaper

Positive-going horizontal-sweep pulses of about 28-volts PP enter the module at #11, and are limited in amplitude by R24 before they reach the base of Q3, the sawtooth shaper. The base has no forward bias except that provided by the

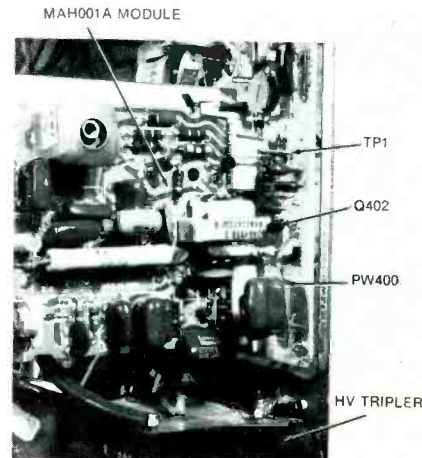

Fig. 2 MAH001A module plugs into the bottom of the PW400 circuit board, just above the tripler HV rectifier. Q402, of the over-voltage protective circuit, is marked with an arrow.

pulses. However, the B/E junction acts as a diode (with the anode at R24, and the cathode grounded), so rectification of the pulses results in a negative voltage at the base. This seems to be reverse bias, and on the average it is. But the tip of each pulse is positive relative to the emitter. Therefore, the transistor amplifies the pulses, and negative-going stronger pulses should appear at the collector. That's why C10 is necessary, for it, in conjunction with R19, integrates the pulses into sawteeth.

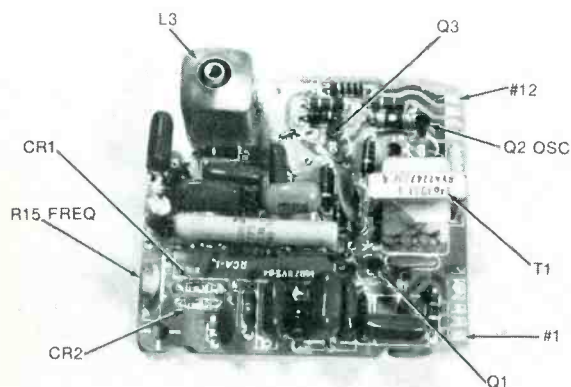
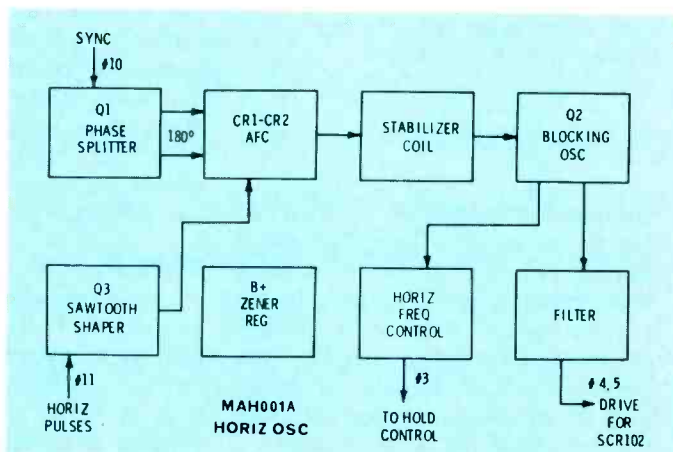

Fig. 1 This is the MAH001A horizontal-oscillator module of the RCA CTC58 chassis. Pin #1 is at the bottom. Transistors and major components are indicated.



The stages and interconnections of the MAH001A horizontal-oscillator module are shown by this block diagram.

Your VTVM is obsolete!

This may sound like a harsh claim, but it's true. Thousands of TV technicians are using instruments designed in the 1950's to troubleshoot circuits designed in the 1970's.

And now, most color TV's have solid state circuits. So use of out-of-date test equipment just compounds the problem.

The generation gap has grown too big.

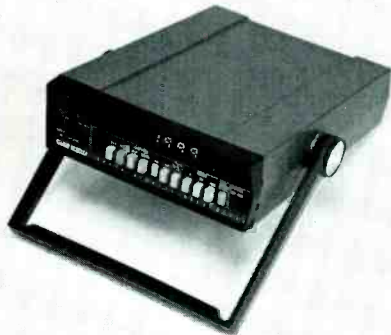

The Fluke 8000A 3 1/2 digit multimeter

Solid state calls for new performance standards.

Your "old fashioned" test equipment simply doesn't measure up to today's requirements. For example, the typical VTVM gives you 5% accuracy and 2% resolution. In the old days, that was good enough. Not so today.

Now you need an instrument to look at the voltages at each pin of an IC with sufficient accuracy and resolution to determine proper IC operation.

For example, a reading of "around 2.8 volts" is no longer sufficient. You must be able to distinguish between 2.80 and 2.82 volts.

You need a test instrument that gives you 0.1 ohm resolution so you can reliably measure resistance of switch contacts, circuit breakers, and low value resistors.

To do all this and more, you need the superior capabilities of the Fluke 8000A 3 1/2 digit multimeter.

An instrument designed specifically for testing solid state equipment.

The 8000A gives you up to 50 times the accuracy and 20 times the resolution of a VTVM, so you can measure the various voltage levels in a solid state chassis with absolute confidence.

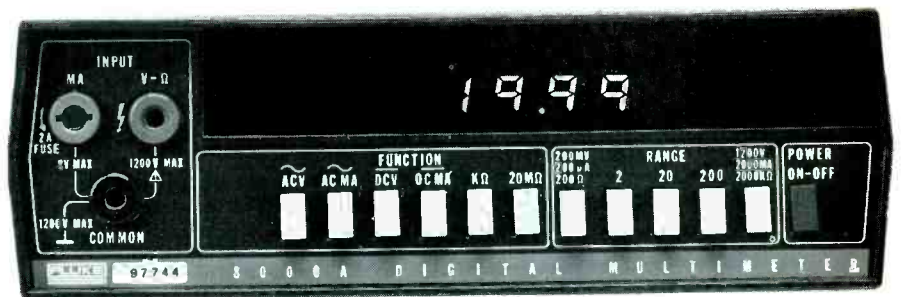

Resolution is 100 microvolts, 100 nanoamps and 100 milliohms

You get the sensitivity you need for low level dc measurements. The 200 millivolt range with 100 microvolt resolution tells you *exactly* what your values are.

The 8000A has an AC frequency response from 45 Hz to 20 KHz and, with accessory probes, to 500 megahertz. Resistance measuring capability ranges from 100 milliohms to 20 megohms. It offers a 15°C to 35°C accuracy temperature span. And a 1-year accuracy time span, meaning it seldom needs calibration.

Unlike other DMM's the 8000A has fast response time—3 readings a second. And the bright, digital readout means that no interpolation is necessary.

The 8000A measures high voltages, too.

Our 8000A is designed to answer *all* the needs of an electronic service technician.

One very important (and talked about!) safety requirement is that the picture tube anode voltage must not exceed the maximum specified by the manufacturer. Our 8000A has an optional high voltage probe that gives you guaranteed accuracy of 1% at 25,000 volts. The probe also extends the capability of the 8000A to 40,000 volts to measure the high voltage in the new 32,000 volt chassis.



High voltage probe accessory gives you 1% accuracy at 25,000 volts

There's new high voltage protection on all ac/dc voltage ranges. The instrument will take transients up to 6 KV, 10 μ seconds wide over a duty cycle of 60 per second.

Get the most up-to-date instrument available.

Don't be caught in the typical trap. Many electronic service shops don't really update their equipment when they decide to update. Switching to a TVM or a FET voltmeter doesn't really give you the accuracy and resolution you need today, or for that matter, tomorrow.

But with the 8000A on hand, you know you have a *true* solid state testing device.



Carry it anywhere. Use it on line or with optional rechargeable battery power (\$50 extra). Note the conveniently mounted specs on the bottom decal.

It costs just \$299 (\$40 more with HV probe).* And it is far and away the largest selling, most rugged and reliable 3 1/2 digit multimeter in the world.

*Domestic only.

For data out today, dial our toll-free hotline, 800-426-0361



John Fluke Mfg. Co., Inc.
P. O. Box 43210, Mountlake Terrace, WA 98043

For More Details Circle (18) on Reply Card

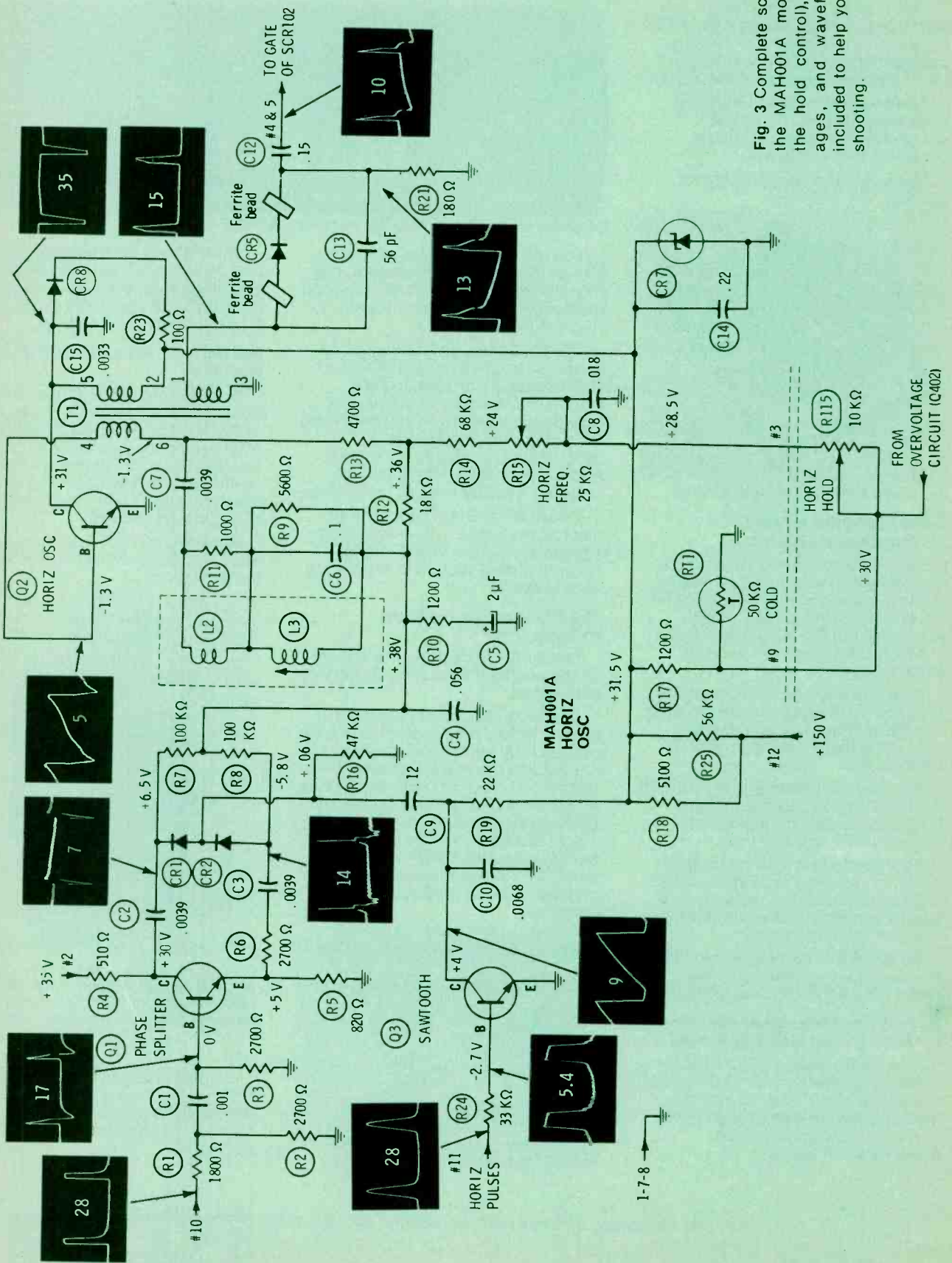

Fig. 3 Complete schematic of the MAH001A module (plus the hold control), DC voltages, and waveforms are included to help your troubleshooting.

The sawteeth are coupled through C9 to the common point of CR1 and CR2, completing all three signals that are necessary for phase detection.

AFC

To the out-of-phase sync pulses, CR1 and CR2 act as shunt rectifiers, producing positive DC voltage at the cathode of CR1 and negative voltage at the anode of CR2. To the sawtooth waveform at the common

connection of CR1 and CR2, the diodes act as series rectifiers, producing positive DC voltage at the cathode of CR1 and negative DC voltage at the anode of CR2.

In normal operation, these two basic types of rectification occur at the same time. And both produce the same polarity of DC voltage at each output. However, the relative phase of the sync signals versus the sawteeth change the amplitude of the instantaneous AC voltage ap-

plied to each diode, thus determining the ratio of positive and negative from which the output voltage is obtained. In other words, the output DC voltage should be capable of any voltage from a small negative, through zero to a small positive, when required.

If the oscillator were a tube, the sum of the positive and negative voltages from the diodes would be zero, when the frequency and phase of the oscillator signal was correct. However, the oscillator is a NPN polarity transistor, which requires a positive base voltage for collector conduction. For that reason, the output of the phase detector (at the junction of R7 and R8) normally is about +0.35 to +0.40 volts, when the locking is correct.

That's all very well, but it eliminates one of the fast tests we could do with the old output of the phase detector to see if the off-frequency oscillator then could be adjusted to the correct frequency (without actual locking, of course). If the correct frequency could not be reached, the defect was in the oscillator. And if it could be

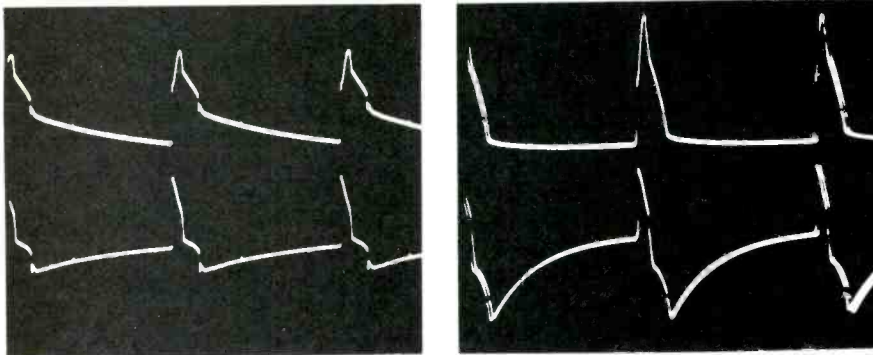

Fig. 4 Top trace of the picture at left is the normal waveform at the junction of CR5 and R21, and the bottom trace is the normal output waveform that drives the gate of SCR102. In the picture at the right, the same points are scoped, but CR5 is shorted. The oscillator is so far out of frequency that the hold control can't lock it.

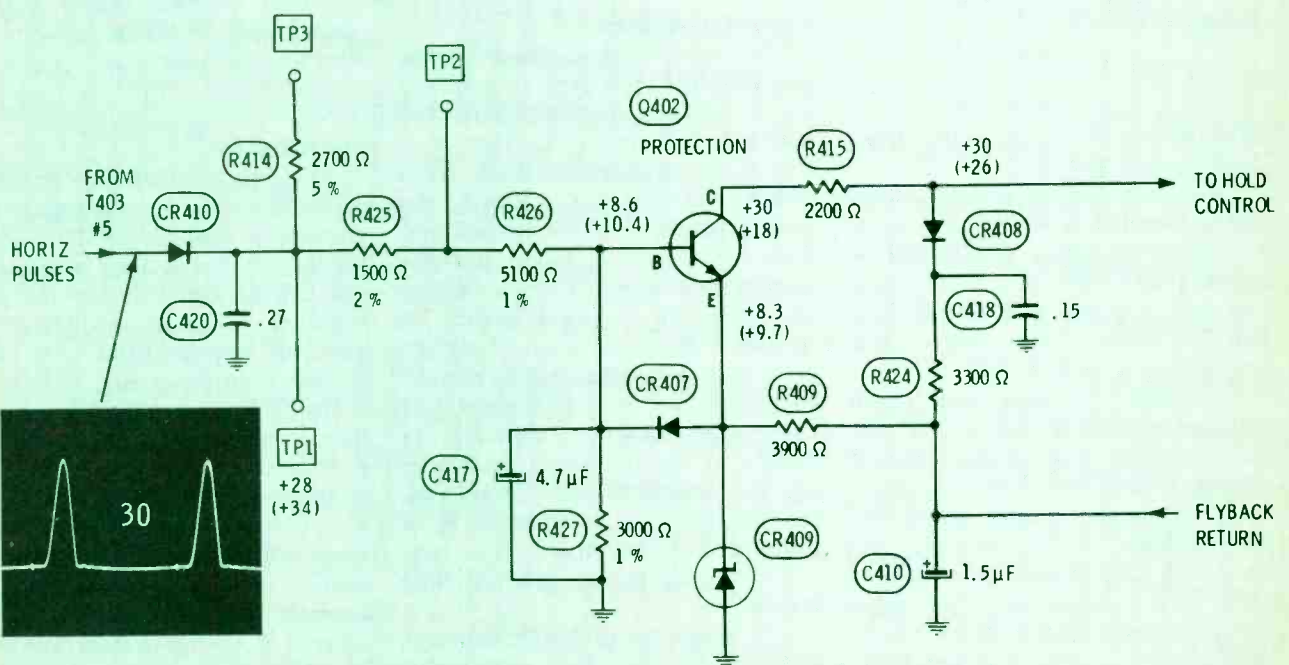
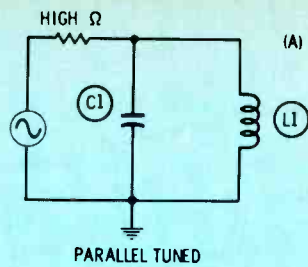
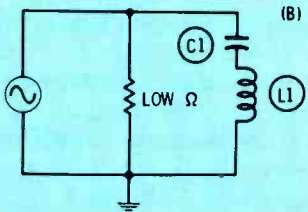

Fig. 5 Excessive HV and pulse amplitude from the flyback causes Q402 to conduct, reducing the positive voltage at the hold control, and driving the oscillator far out of frequency. There are no adjustments, so several of the resistor values are critical. Notice the tolerances.



PARALLEL TUNED



SERIES TUNED

SERIES TUNED IS PARALLEL TUNED WITH DRIVE SIGNAL INJECTED IN SERIES WITH C1 AND L1

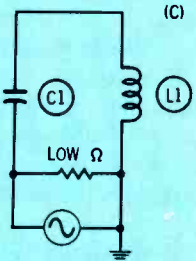

Fig. 6 A parallel-tuned resonant circuit is shown at (A), and a series-tuned circuit is drawn at (B). (C) shows that a series circuit differs from a parallel one only in the method of inserting the input signal, and where the output signal is obtained. Therefore, one explanation covers both.

adjusted to frequency, the phase detector was bad.

Of course, the DC control signal at the junction of R7 and R8 could be clamped to about +0.35 volt by a bias pack. Then you could apply the same logic to find which stage has the defect. But that's extra trouble.

Probably the best way is to measure the 3 voltages at R7 and R8, compare them to the ones in Figure 3, and use logic to determine where the trouble might be. For example, if CR1 shorted, the anode of CR2 would be about -4 volts, the cathode of CR1 (also anode because of the short) might measure +1.2 volts, and the junction of R7 and R8 would be around -0.3 volt. This would reduce the forward bias of the oscillator, making the oscillator run slow, with

about 13 stripes slanting down to the left on the screen of the picture tube.

Test measurements proved that adjustments of the horizontal-hold control could produce a variation at the junction of R7 and R8 from about +0.68 to +0.06 volts DC **before the oscillator would fall out of lock.** That means the AFC circuit can vary the control voltage at the output about 0.6 volt, when trying to bring the oscillator back to the correct phase with the sync pulses.

The anti-hunt components are C4 and R10/C5. If R10 and C5 open, the vertical lines in a picture would be bent in several sine wave curves. C4 slightly slows down the speed of correction enough to prevent overshoot, while permitting correction of each horizontal-scanning line. The series connection of R10 and C5 provide long-term voltage storage that helps eliminate any hook at the top of the picture.

We have established now that the AFC phase detector operates to supply a slight positive, zero, or small negative voltage to the positive bias of the oscillator to pull it back into phase with the station signal.

Horizontal oscillator

The horizontal-oscillator stage, including Q2, operates as a blocking oscillator. Superficially, the wiring seems similar to that of a sine-wave oscillator. Both have transformer coupling to provide the proper phase between output and input. However, the important difference between the types is in how the frequency is determined. A sine-wave type has a tuned circuit in it that resonates at the desired frequency; so, the transformer and associated tuning capacitors mainly set the frequency. In blocking (or multivibrator) oscillators, the frequency is determined by a capacitance-resistance time constant, usually in the grid or base circuit.

C15 seems to tune the collector winding of T1. But the pulse waveform there proves the value is too small for tuning.

Here is the way this blocking oscillator works: the input (base)

and output (collector) windings of T1 are phased the same, so the base and collector are negative-going at the same time. Forward bias for the oscillator comes through the horizontal-frequency and horizontal-hold controls, making Q2 conduct. The collector conduction sends a negative-going pulse through T1 to the base, cutting off the forward bias and the C/E current. This charges C7 to a negative voltage (of course, the ground side of C7 goes through L2, L3, and C4; but for the sake of simplicity, we will act as though C7 were grounded.) Positive voltage comes in through R17, R115, R15, and R13, gradually bringing the T1 end of C7 up to a positive voltage. When the base becomes positive enough, Q2 has collector current, which quickly sends a negative pulse to the base circuit, reverse biasing the base and cutting off the collector current. That's slightly more than one cycle.

Therefore, the repetition rate is determined mainly by the capacitance of C7 and C4 in series versus the sum of R17, R115, R15, and R13; and two of the resistances are variable. R15 (on the module) sets the approximate range, and R115 (on the rear panel of the chassis) is the hold control. Notice that an open in any of those resistors will stop the oscillator.

Stabilizing coil

Sine-wave stabilization, similar in principle to that in many older tube circuits, is supplied by L2 and L3, which are connected between C7 and C4. L3 and C6 tune the pulse supplied to them, giving a sine wave of approximately the horizontal-sweep frequency.

Here's how to adjust for correct frequency and locking:

- connect a jumper from the base of Q1 to ground (eliminates sync);
- connect a short jumper wire across C6 (eliminates the stabilizing coil);
- preset the hold control (R115 on chassis) to the mechanical center of its rotation;
- adjust R15, the horizontal-frequency control on the module, for the nearest locking (one picture, floating by slowly);

- remove the jumper wire from C6, and adjust the core of L3 for the same frequency as before;
- remove the ground from the base of Q1, and reset the hold control for best locking.

It should be possible at either end of the hold control to force the oscillator out of lock, with best locking near the center.

Oscillator output

A third winding of T1 supplies the positive-going pulses that are the output signal from the oscillator. CR5 and R21 form a clipper, which passes only the sharp tips of the output pulses, and C12 couples the signal to the gate of SCR102, the retrace SCR.

I was surprised to find that the horizontal would go far off frequency when CR5 was shorted. In fact, it was not possible to restore the locking by using the hold control. Figure 4 shows both sets of waveforms.

B+ power

B+ power for the module comes from the +150-volt main power supply, which enters at terminal #12. R18 and zener CR7 regulate voltage for the circuits at about +32 volts. If the zener should open, it's likely at least two of the transistors would fail.

Over-Voltage Protection

If the high-voltage becomes too high, the over-voltage protection circuit, which includes Q402, operates to throw the horizontal oscillator out of lock. This works in two ways. Because the picture is out of lock, and cannot be brought into lock with the hold control, the viewers are discouraged from using the TV until it is repaired. Secondly, the oscillator operates at a lower frequency, and this reduces the high voltage somewhat. For example, one CTC58 had 24 KV in normal operation, almost 29 KV without any regulation (but with the protective circuit reducing the oscillator frequency,) and over 31 KV without regulation and with the protective circuit defeated by grounding the base of Q402.

Circuit diagnosis

Briefly stated, Q402, the protec-

tion transistor, has insufficient forward bias, when the HV is normal or below. Excessive amplitude of the sweep signal from the flyback causes Q402 to conduct heavily, reducing the positive voltage available to the hold control. This reduced positive voltage to the base of the oscillator forces it to run at a lower frequency.

Horizontal pulses from terminal #5 of the flyback transformer (T403) are rectified by CR410, while C420 makes it peak-reading and removes most of the ripple. Refer to Figure 5 for the schematic.

A voltage divider consisting of R425, R426, and R427 provides a positive base voltage that varies in step with the high voltage and the flyback pulses. Emitter voltage is supplied by R409 and regulated by zener CR409 at about 10 volts. The collector obtains its voltage through R415 from R17, which supplies the positive voltage for the horizontal-hold control.

B/E bias of Q402 is about +0.25 volt when the HV is normal, and about +0.7 when the HV is excessive. The schematic shows the important voltages with and without the protective circuit in operation.

Notice that the base resistors have 1% or 2% tolerance for accuracy, since no adjustment is provided. Also, several testpoints are marked on the PW400 board where this circuit is located. If TP1 and TP2 are shorted together the circuit should force the oscillator off frequency, even when the HV is normal. Also, grounding TP2 should bring the oscillator back into lock if you want to test for a defect in the protective circuit, or determine if the protective circuit is the reason for the oscillator being off frequency.

Horizontal Sweep By Ringing

In the conventional tube-powered horizontal-sweep circuit, the right half of the raster is deflected by a sawtooth of current from the output tube, retrace to the left edge is by ringing (triggered by the sudden stoppage of output-tube current,) and deflection from the left edge back to the center is from current through the damper, which is clipping the negative peak of the

ringing sine wave. High voltage is produced by rectifying the huge positive pulse that is created at the middle of retrace because of the ringing.

By comparison, the RCA deflection system with SCR's uses ringing for both scan and retrace. Diodes and SCR's operate as switches to supply the yoke with part of a 8-KHz sine wave for trace and with part of a 35-KHz sine wave for retrace.

To complicate matters, the retrace circuit supplies power also for part of the trace time. What's more, another ringing circuit controls the amount of power that's fed to the deflection circuit in order to regulate the high voltage.

It's strictly impossible to understand how these SCR circuits operate without a thorough knowledge of ringing. So, that is the next subject to be explained in detail.

Parallel Or Series Tuned

Tuned circuits are of two basic types, either parallel tuned or series tuned. Figure 6A shows typical wiring of the parallel type. Drive for the circuit should be high impedance (such as a pentode tube, or through a high-value resistance.) The impedance of the parallel combination of inductance and capacitance is maximum at the resonant frequency; therefore, we might say that the tuned circuit is driven by the voltage part of the input signal.

A series-tuned circuit (Figure 6B) operates best when driven by a low-impedance source, because the impedance of the inductance and capacitance in series is minimum at resonance (driven by current.)

Those conditions are true when looking at them from their effects on the **sources**. However, if we consider only the **circulating** currents (internal current between inductance and capacitance in each type), the two circuits are identical! As shown in Figure 6C, a series-tuned circuit is the same as a parallel-tuned, except the input driving signal is injected in series with the two components.

Therefore, for the following study of ringing, only a "parallel"-tuned circuit will be shown, even though most of the resonant circuits of the

Fig. 7 These are the internal voltages and currents of a tuned circuit during the first four quarter cycles of ringing, after the external power has been turned off. Both currents and voltages have sine waveshapes.

RCA sweep circuit are series tuned.

The Anatomy Of Ringing

Ringing is the action of a tuned circuit when it is shock excited. In brief, it involves the flow of voltage and current from inductance to capacitor, capacitor to inductance, and so on until losses terminate the operation.

Figure 7 follows a tuned circuit

through one complete cycle. Study it carefully, for it explains much that is essential for understanding the complete SCR circuit to be clarified next month.

Remember that current must increase slowly through an inductance, and it cannot stop suddenly; it must flow into **something**, decreasing slowly (in this case into the capacitance part of the tuned

(A) Power to start the ringing of the tuned circuit comes from a battery. A strong "positive" current is flowing, and the voltage is almost zero (compared to the higher voltage to be produced by ringing).

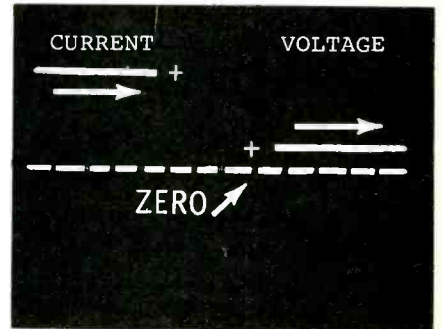
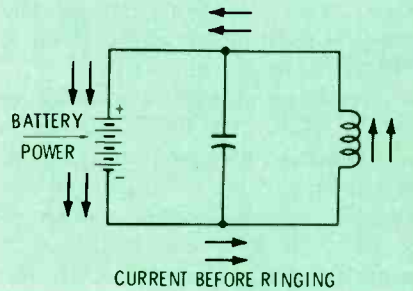

(B) During the 1st 1/4 cycle of ringing, the source of power is the "positive" current of the inductance, which was maximum when the battery was disconnected. The "positive" current gradually decreases as the electrons flow into the capacitance, building up a "negative" voltage.

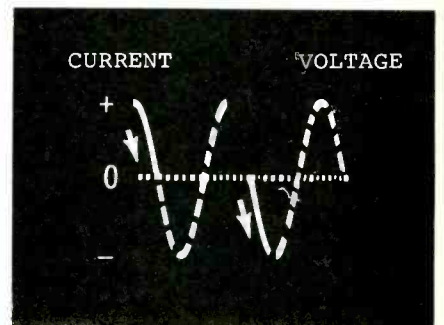
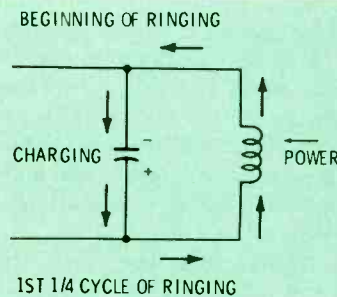

(C) At the end of the 1st 1/4 cycle, the current is zero, and the capacitance has a very high "negative" voltage.

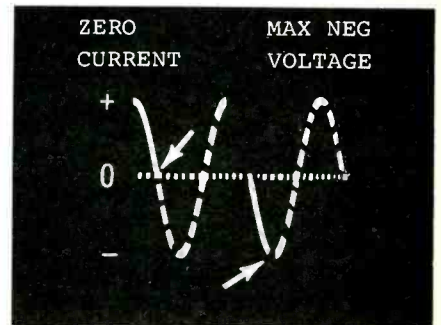
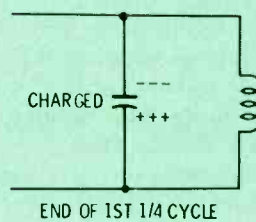

(D) Source of power during the 2nd 1/4 cycle is the "negative" voltage charge of the capacitance. This voltage decreases toward zero, as it forces an increase of current in the "negative" direction.

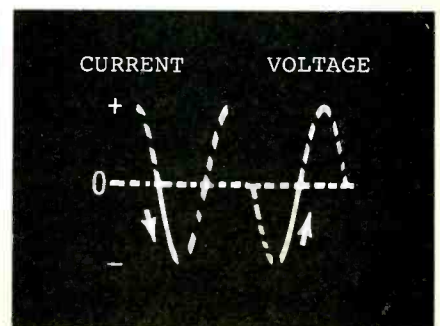
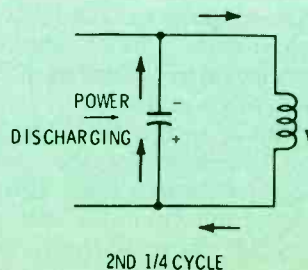

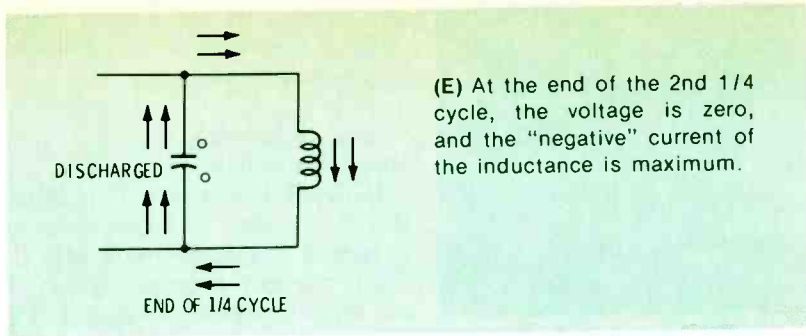
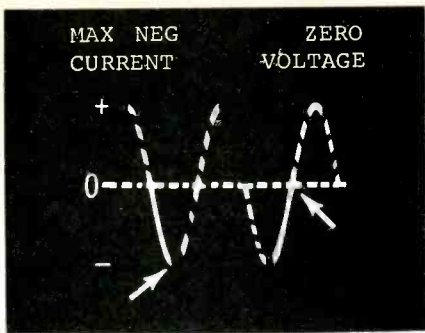

(E) At the end of the 2nd 1/4 cycle, the voltage is zero, and the "negative" current of the inductance is maximum.

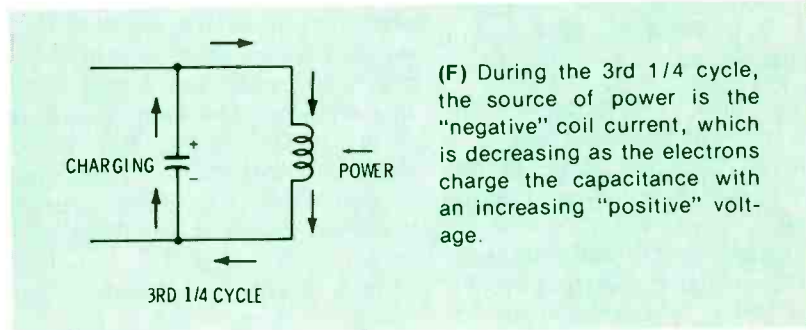
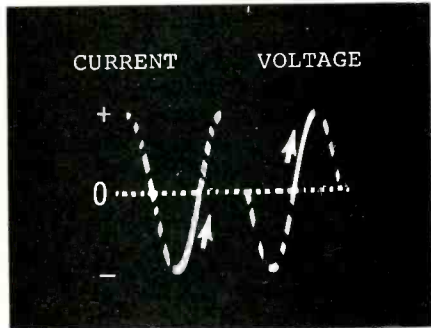

(F) During the 3rd 1/4 cycle, the source of power is the "negative" coil current, which is decreasing as the electrons charge the capacitance with an increasing "positive" voltage.

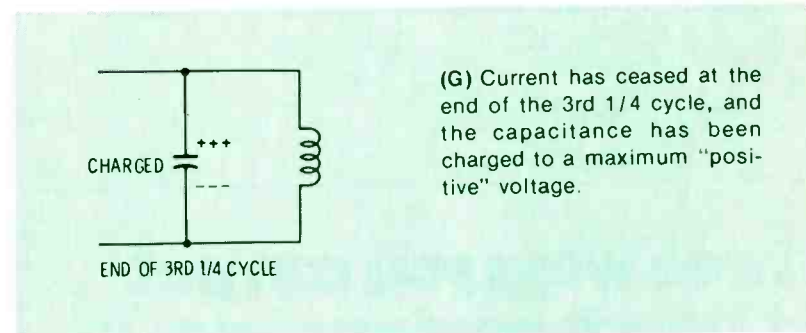
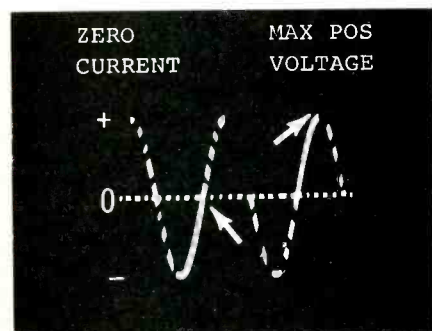

(G) Current has ceased at the end of the 3rd 1/4 cycle, and the capacitance has been charged to a maximum "positive" voltage.

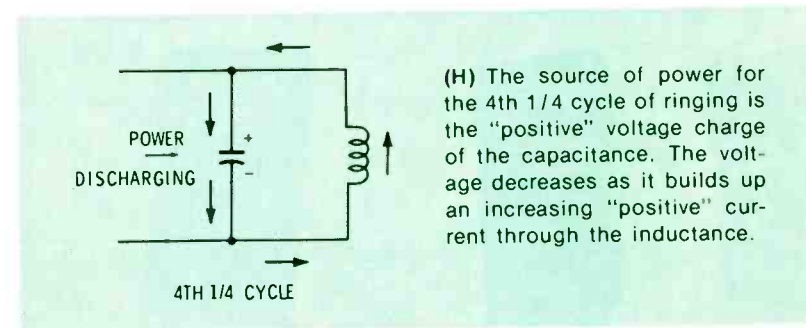
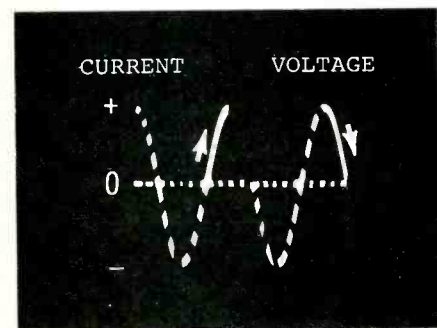

(H) The source of power for the 4th 1/4 cycle of ringing is the "positive" voltage charge of the capacitance. The voltage decreases as it builds up an increasing "positive" current through the inductance.

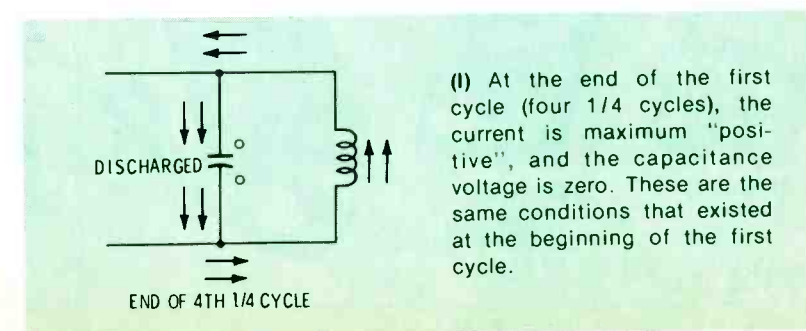
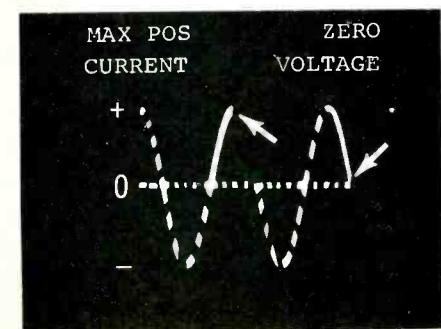

(I) At the end of the first cycle (four 1/4 cycles), the current is maximum "positive", and the capacitance voltage is zero. These are the same conditions that existed at the beginning of the first cycle.

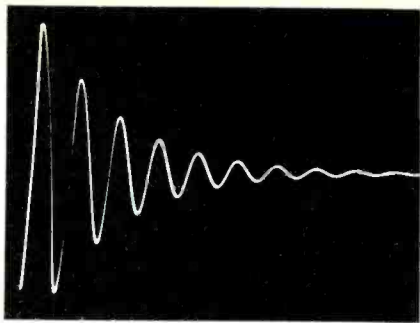

Fig. 8 If allowed to proceed, the ringing becomes a series of sine waves having gradually decreasing amplitude, because the losses bleed the power. Often, the waveform is called a "damped wavetrain".

circuit.) Also, a capacitance requires time to become charged or to be discharged. The arrows indicate the direction of electron current.

One more point: you will notice that the voltage and current are 90° out of phase. This is true for the **internal** circulating current and voltage, and does not contradict the textbook truism that the **voltage**

and current of the driving source feeding a parallel-tuned circuit are in phase at resonance.

Smaller capacitance gives larger voltage

Most electronic men have heard that the smaller the capacitance for a certain resonant frequency the higher the gain (that is, higher "Q", or higher signal voltage.) The reason is **not** because inductances are more efficient than capacitances, but because of the way electrons are stored in capacitors. As an analogy, suppose you poured a gallon of water into a pan of one foot diameter. The water would rise to a certain height. But if you poured another gallon of water into a pan that was four feet in diameter, the water would not be so deep.

So it is with capacitances, if you charge a 1 microfarad capacitor with 3 amperes of electron current, the voltage developed will be twice as high as it would be if the

capacitor were 2 microfarads. With the circuit of Figure 7, and a 6-volt battery for starting power, it's possible to develop more than 100 volts by the resonant or ringing action.

This explains how the horizontal-retrace circuit of the CTC58 can have **more** voltage than is furnished by the power supply. And how the 3-microfarad yoke capacitor has so little voltage developed across it compared to that across the .075 microfarad retrace capacitor (C406).

Next Month

Many unusual waveforms (including current waveforms, and waveforms with average DC voltages indicated) help to explain the complex circuit actions of the horizontal-sweep section of the RCA CTC58, the one with SCR's and diodes that switch the tuned circuits.

The circuit is difficult to understand, but it's interesting and well worth the effort. **Don't miss it!** □

Three ways you can put test bench performance in your pocket with Hickok.



Model 215
A fully automatic in-circuit semiconductor analyzer.
\$138

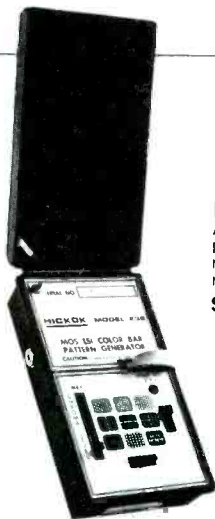

Model 239
A rock-solid MOS LSI color bar generator.
\$115

Model 350
A true auto polarity 10 megohm FET multimeter
\$119



Now you can take the equipment you need wherever you need it with these versatile pocket performers from Hickok.

Our Model 215 Pocket semiconductor analyzer checks transistors, FETs, diodes and SCRs for conductance and gross leakage and identifies base or gate leads both in and out of circuit. And it does it all with a self-sequencing good/bad test and LED display.

The Model 350 Pocket FET multimeter features foolproof overload protection, true auto polarity, a polarity indicator and 10 megohm input impedance. It measures 9 dc voltage ranges, 9 ac voltage ranges, 7 hi/low resistance ranges and decibels. And it displays its findings on a long 2.4" mirrored arc.

Hickok-developed MOS LSI ICs give our Model 239 Pocket Color Bar Generator exceptional reliability, extremely low battery drain, rugged industrial performance and crystal stability. Simple matrix switches select any of its nine patterns, including a gated rainbow. And you can put its output on channels 2, 3 or 4.

But don't just take our word for the way these midget marvels perform. Ask your Hickok distributor for a demonstration. He may even offer a 10 day trial. Then we've got you for sure.

HICKOK

the value innovator
INSTRUMENTATION & CONTROLS DIVISION
THE HICKOK ELECTRICAL INSTRUMENT CO.
10514 Oupont Avenue • Cleveland, Ohio 44108
(216) 541-8060 • TWX: 810-421-8286

For More Details Circle (11) on Reply Card

CARTOON CORNER



"OFFICER JOE BLAKELY, WHAT A COINCIDENCE! I JUST HAPPEN TO BE ON MY WAY TO YOUR HOME."



"TOGETHER WE COULD MAKE BEAUTIFUL PATTERNS ON THE OSCILLOSCOPE OF LIFE."



"TONIGHT OUR SPONSOR HAS AGREED TO FOREGO THE REGULAR PROGRAM IN ORDER THAT YOU MAY ENJOY UNINTERRUPTED COMMERCIALS."

Antenna Action from

ACA

JUMBO

AC/747 FOR LONG HAULS

82 CHANNEL VHF-UHF FOR COLOR OR BLACK & WHITE

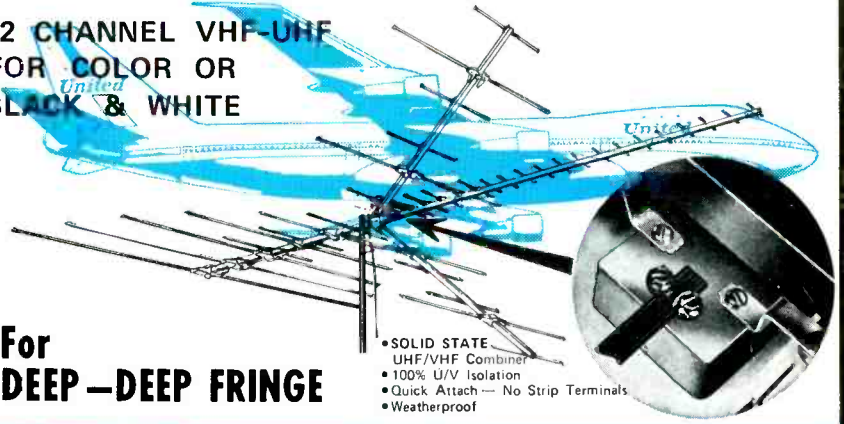

For DEEP-DEEP FRINGE

- SOLID STATE UHF/VHF Combiner
- 100% U/V Isolation
- Quick Attach — No Strip Terminals
- Weatherproof

JUMBO AC-747 for DEEP - DEEP FRINGE

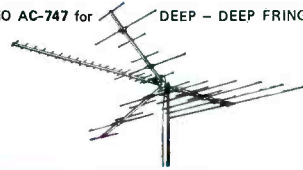

- 48" VHF CORNER DIRECTOR SYSTEM
- 48" UHF Corner Reflector • 63 TOTAL ACTIVE ELEMENTS
- Boom Length 136" 22 Driven Elements
- Double Mast Clamp 31 Directors
- Includes UHF Power Pac 10 Reflectors
- Blue Boom — Gold Elements

DC10 for DEEP FRINGE



- 34" VHF CORNER DIRECTOR SYSTEM
- 34" UHF Corner Reflector • 43 TOTAL ACTIVE ELEMENTS
- Boom Length 78" 18 Driven Elements
- Double Mast Clamp 18 Directors
- Blue Boom — Gold Elements 7 Reflectors
- Correlator Phasing for Perfect Match and Increased Gain.

AC-727 for FRINGE AREA



- 28" VHF CORNER DIRECTOR SYSTEM
- 28" UHF Corner Reflector • 35 TOTAL ACTIVE ELEMENTS
- Boom Length 60" 14 Driven Elements
- 13 Directors
- 8 Reflectors
- Correlator Phasing for Perfect Match and Increased Gain.
- Blue Boom — Gold Elements

POWER PAC PP800 For Additional UHF Gain For OC10 and 727

- 10 Additional UHF Directors for DC10 & 727.

ACA

P.O. Box 865, Highway 61 North Burlington, Iowa 52601

LINE UP TODAY WITH ACA!

SEE YOUR DISTRIBUTOR OR WRITE

For More Details Circle (10) on Reply Card

Servicing stereo audio systems



Part 5, By J. A. "Sam" Wilson, CET Technical Advisor For NESDA

Monaural, stereophonic, and quadriphonic reproduction of music are described, with emphasis on the principles of discrete and matrixed four-channel sound.

Audio signals are recorded and played in three basic formats: monaural (one-channel); stereophonic (two channel); and quadriphonic (four-channel). We will describe them as they appear as tracks on the tapes of magnetic recorders.

Monaural Sound

A typical monaural tape format is shown as a block diagram in Figure 1. One-half of the tape (less the guard bands) is used for recording and playback in one direction. At the end of the tape, the reels are inverted (right is turned over to become left, and left becomes right) so the other half of the tape also can be used.

Monaural sound can be of hi-fi quality, but it has no directional effects, causing hi-fi enthusiasts to complain that it is like sound coming through a tunnel.

Despite this limitation, there are applications (such as voice reproduction of speeches, phone calls, or dictation) where monaural is adequate. Of course, computer control or numerical control also operates on one channel. But for music reproduction, there is little interest in monaural.

Stereophonic Sound

With stereophonic sound, two channels are recorded and two are played back (Figure 2). This gives some dimension or directivity to the sound. Two reproduced sources of sound gives a slight difference in the volume (amplitude) of each channel, and a difference in the time of arrival (phase).

Unfortunately, some listeners feel that if a little is good, then more must be better. So, they move the speakers far apart to increase the stereo effect. The result is the so-called "ping-pong" or "hole-in-the-middle" effect, with the sound coming from two distinct side sources, but with very little coming from the middle.

This artificial sound can be remedied by adding a third speaker in the center and feeding it with some audio from both channels. Or, the two speakers can be moved closer together.

No ambience

Both monaural and two-channel stereo sounds lack "ambience",

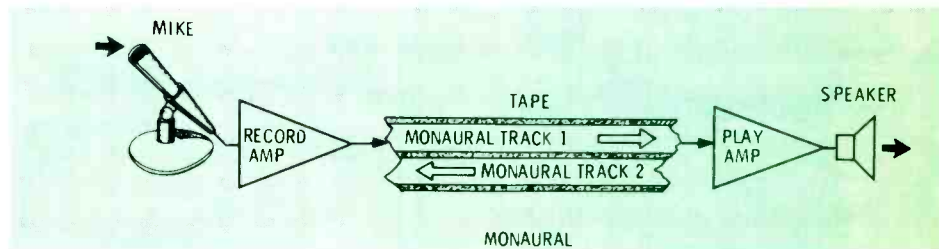

Fig. 1 Some monaural tape recordings use the full width of the tape, and others have four tracks made consecutively. But most reel and cassette monaural recordings have two recorded tracks of one-half the width of the tape. One is made, then the reels or cassettes are turned over. This reverses the tape movement, and a second half track is recorded to the beginning.

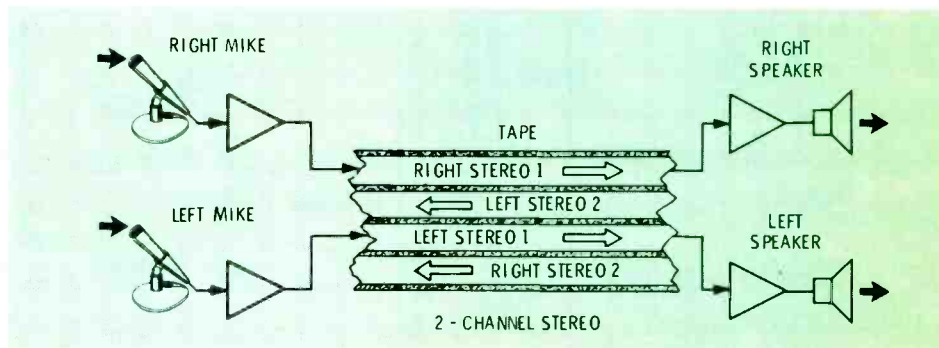

Fig. 2 Two-channel stereo can be recorded and played with two separate tracks used simultaneously. The reels are turned over for the other two stereo tracks.

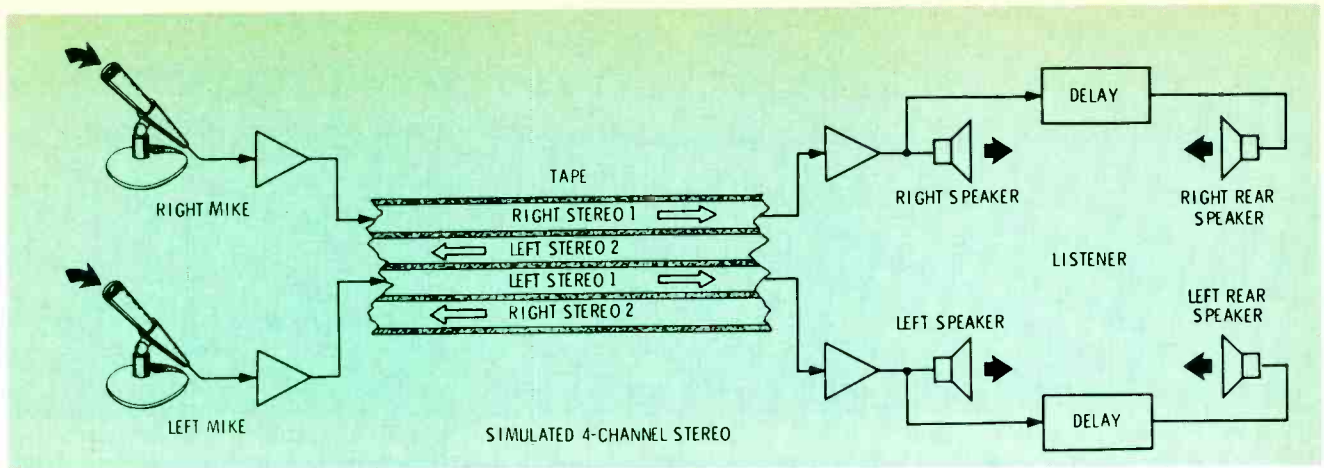

Fig. 3 Four-channel stereo with ambience can be simulated by a conventional two-channel program when the two rear speakers are supplied with sound that has been delayed in time.

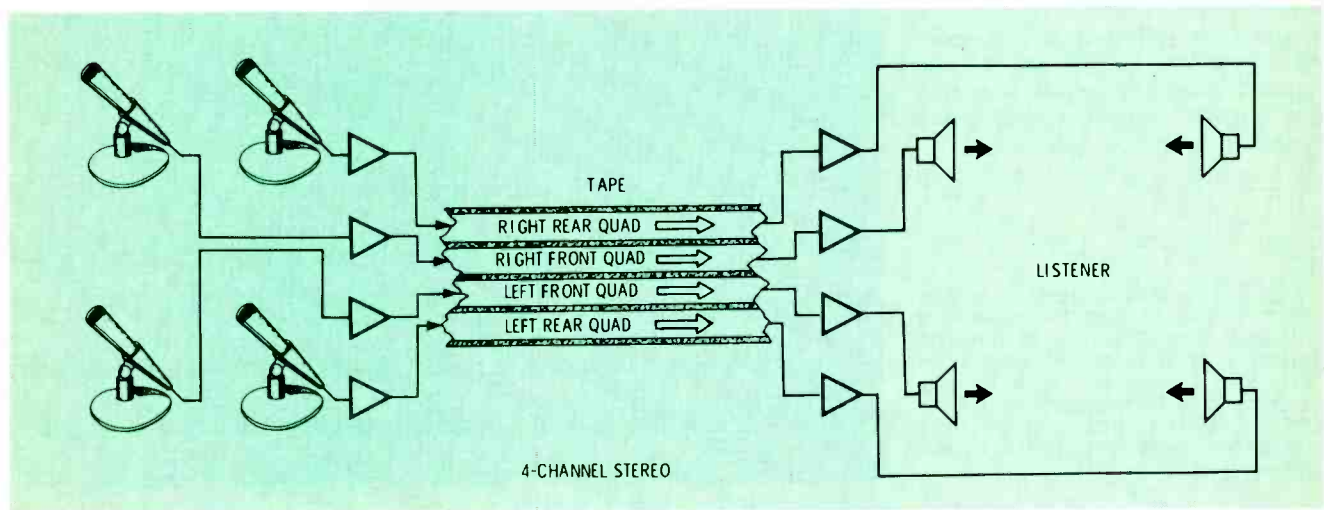

Fig. 4 True four-channel stereo has four separate and identical channels from the mikes, through the recording, and on to the speakers. These tapes are not turned over, but play through once before re-winding.

which means "on all sides" or surrounding. When you hear music in an auditorium, you not only hear sounds coming from the stage in front, but also sounds that have been bounced off of the side walls, rear wall, and the ceiling. You are surrounded by sound, and your ears can sense this.

Quadriphonic (four-channel) sound is a practical means of recreating music with ambience.

Four Channel Sound

Quadriphonic sound comes in three basic formats: imitation; discrete; and matrix.

Imitation quadriphonic sound

Figure 3 shows the principle of imitation quad sound, using a conventional stereo recording. For

the ambience, two additional speakers are added behind the listener, and they are fed audio that has been slowed by delay lines. The idea is to imitate the time delay of any sounds coming from the rear of an auditorium.

When the time delay has artificial reverberation added, the effect can be very pleasing. However, the quality is not the same as with true ambience.

Discrete quadriphonic sound

Discrete means separate and distinct, and that describes the quad channels shown in Figure 4. Four microphones pick up the sounds at four locations, and the four channels are separate right up to the four speakers.

Really, this is the only true

recorded discrete four-channel system. With discs called discrete, the four channels are not completely separate, but two are recorded with the usual 45/45 system, and the other two modulate a sub-carrier, where they must be removed by processing and demodulation. However, the four-channel quality can be excellent when all parts of the system are performing perfectly.

The only disadvantage of the tape discrete quad method of Figure 4 is that it uses a lot of tape for the length of the recording. Because of the four separate tracks, the playing time is just half that obtained with a two-channel format.

Matrix quad sound

One method for solving the playing time problem and allowing

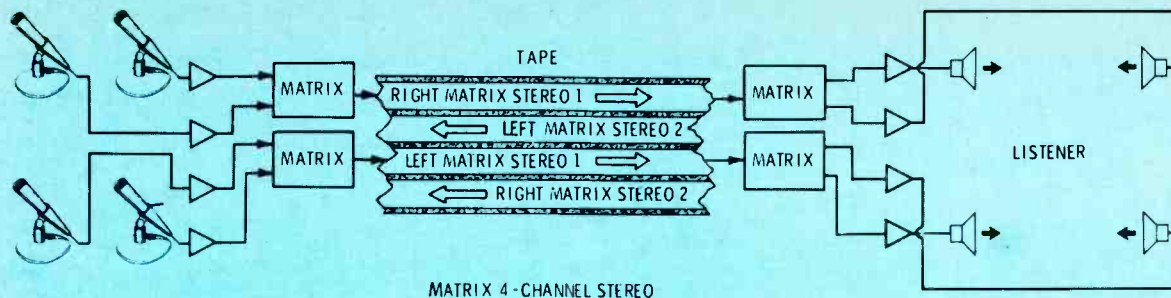

Fig. 5 To increase the playing time and permit a four-channel effect that can be broadcast over two-channel FM stereo, several matrix systems have been developed. Microphone signals are combined, usually by shifting the phase of one, to give two stereo channels that go through tape or disc recording and playback in the usual way. In the playback system, the two signals of each channel are separated by a reversed matrix process, giving four channels for four speakers.

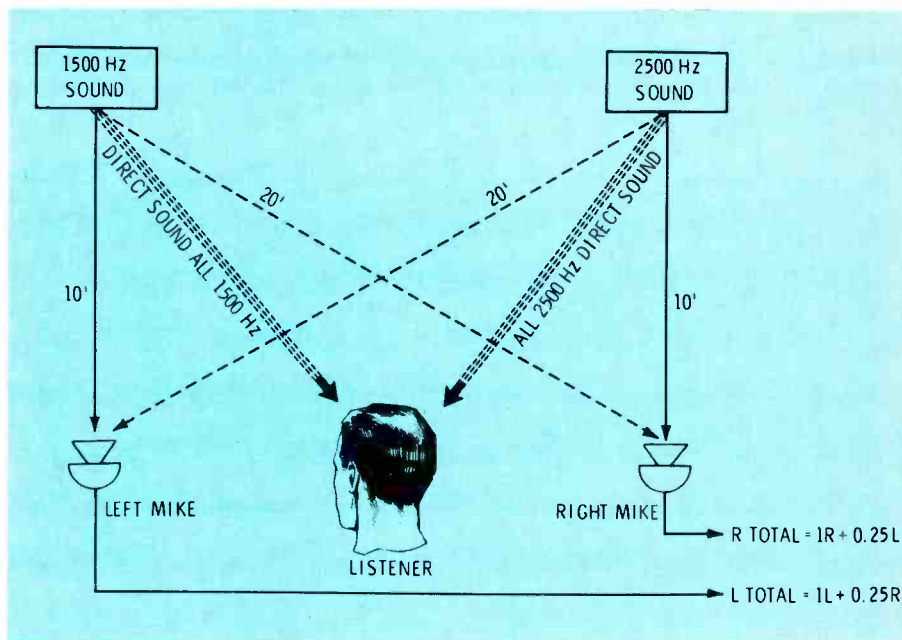

Fig. 6 Two microphones operated in stereo do not hear the same as a listener does. Because of binaural hearing, a listener discerns both sources of sound, without any mixing. The microphones each hear **both** sounds, the nearer tone stronger, and the distant one weaker.

a degree of compatibility with two-channel systems is shown in Figure 5. Although four microphones are used, their audio signals are matrixed in pairs to produce two stereo channels. In this form, they are recorded and played back (either by tape or by discs), then dematrixed into what is **hoped** to be the four original audio signals to drive the four speakers.

Unfortunately, it's very difficult to design any matrix system which can recover the true original signals. Added to this is the need for compatibility, so the music sounds good on a two-channel system as well.

Unfortunately, there is no agreement on a standard matrixing system. Several formulas are being used at present, and they are not totally compatible with each other. When the music has been recorded by one matrix system and played with another, the results often are

unpredictable, although the music sometimes is interesting and novel. Several different decoders would be required to reproduce correctly all of the quad matrix recordings.

To better understand matrixing, we will examine a two-channel stereo system with simple matrixing included to extract the two original "pure" signals.

Simple Matrixing

What a listener hears compared to what two stereo microphones hear is shown in Figure 6. Because of human binaural hearing, the listener perceives two separate sources of pure audio tones. But each microphone hears one tone loudly and the other softly, because of the "square law". (Sound levels vary inversely as the square of the distance. So, a source of sound will be nine times louder when it is three times nearer.)

Each mike, therefore, has 1 unit

of volume from the nearest sound source, plus 1/4 unit from the more-distant source. If the audio signal from each mike is amplified and fed to a speaker occupying a similar spot in another room (Figure 7), a listener in the second room will not hear the two pure tones from the same relative locations as in the original room. That's because each speaker (sound source) now has 25% (or -12 dB) of the other tone added to the desired one. The stereo directional effect has been degraded.

Example of matrixing

Addition of some simple matrixing circuitry can restore 94% of the original pure tones without contamination or crosstalk between them. As shown in Figure 8, each speaker has added to its signal 25% of an **inverted** signal from the other channel. Thus, the minus 25% cancels the plus 25% unwanted

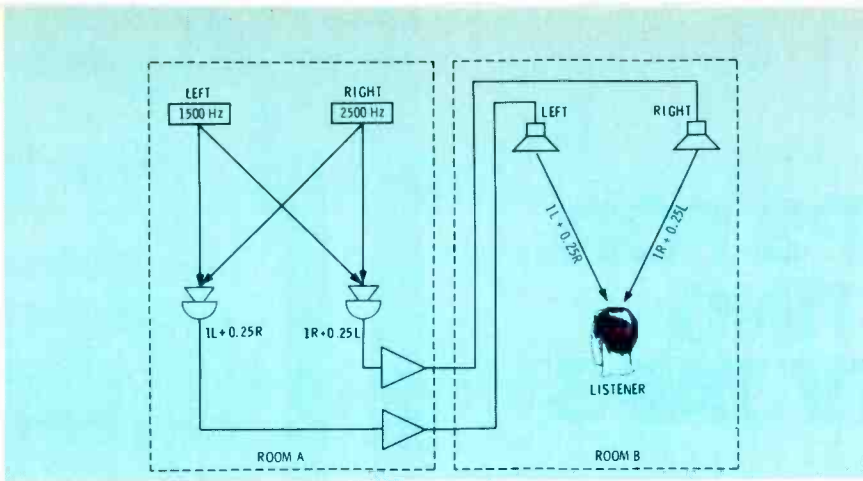

Fig. 7 Amplifying the audio signals from the microphones in room "A" (Figure 6), and placing the speakers in room "B" at the same relative location as the original sound sources, does not give a listener there the same stereo directional effect as obtained in room "A". The left signal in the right speaker and the right signal in the left speaker will make the sound sources seem closer together than they really are.

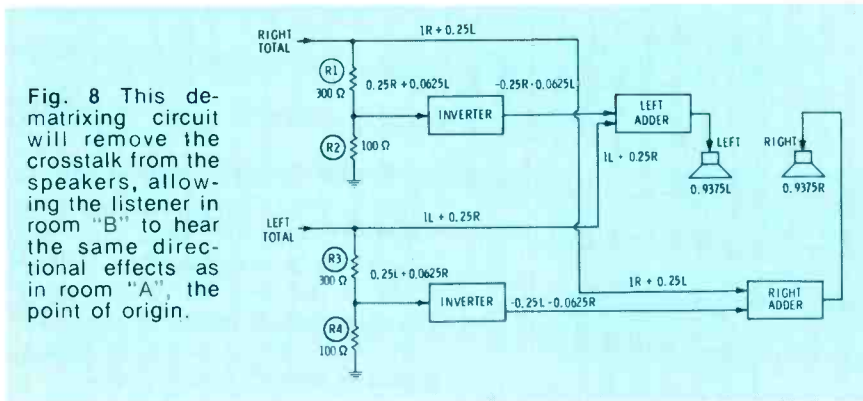

Fig. 8 This dematrixing circuit will remove the crosstalk from the speakers, allowing the listener in room "B" to hear the same directional effects as in room "A", the point of origin.

signal formerly added by the square law.

Let's go through the mathematics of Figure 8. The two channels are mirror views, so only one will be analyzed.

In order to cancel the .25 unit of "left" signal present in the total right signal, a signal of -.25 "left" must be added. This signal is obtained from the left channel. First, the voltage divider R3/R4 reduces the total left signal to 25% of the original amplitude. Then the 0.25L + 0.0625R output of the voltage divider goes through an inverter having a gain of 1. Now the signal is -0.25L - 0.0625R, which goes to the "right adder" where it's added to the 1R + 0.25L total right signal.

Output of the right adder follows this calculation:

$$\begin{array}{rcl}
 +1.0000R & + & 0.25L \\
 -0.0625R & - & 0.25L \\
 \hline
 +0.9375R & &
 \end{array}$$

The right signal has suffered a small loss of amplitude but, as it drives the right speaker, it is without any crosstalk from the left signal.

Correction of the left total signal is done in the same way by R1/R2, the inverter, and the left adder, which drives the left speaker.

If this exact principle were used in a practical circuit, the inverters and adders would operate at low amplitude in stages prior to the audio driver and output stages.

Of course, the dematrixing circuits of commercial quad systems are much more complex than the one just described, although the basic principles are the same. □

COST EFFECTIVE COMPONENTS

New Guaranteed Tubes

	\$1.41	Zenith IC's	
3A3			
6BK4	2.40	221-42	\$1.30
6DW4	1.57	221-45	1.50
6FQ7	1.11	221-46	1.00
6GF7	1.78	221-62	1.40
6HA5	1.35		
6JC6	1.55		
6JE6	2.81		

C.E.C.'s First Line Transistors

		Equivalents		
CEC	TR01	162	SK3079	GE
CEC	TR02	123	SK3122	61 .34
CEC	TR03	159	SK3114	67 .34
CEC	TR04	152	SK3041	14 .75
CEC	TR05	241	—	— 1.30
CEC	TR06	197	SK3085	— 1.90

		Equivalents		
ICs	IC01	714	SK3075	IC04
CEC	IC02	731	SK3173	— 1.50
CEC	IC03	713	SK3077	IC05 1.00
CEC	IC04	790	—	— 1.40
CEC	IC05	712	SK3072	IC02 1.50
CEC	IC06	709	SK3135	IC11 1.00
CEC	IC07	710	SK3102	— 1.00
CEC	IC08	725	SK3162	— 1.00
CEC	IC09	718	SK3159	IC08 1.00
CEC	IC10	720	SK3160	IC07 1.00
CEC	IC11	723	—	— 1.30

C.E.C. Specials

VHF Matching Transformers 75-300	10 for \$6.50
160 MFD 250 VDC Filters 1"	10 for 9.00
160 MFD 250 VDC Filters 1-3/8"	10 for 11.00
Japanese transistor kit 20 most popular	8.25
Miniature electrolytic kit 25 popular types	8.25
2 amp 1kv Diodes	100 for 19.00
Sony Replacement Antennas	3 for 7.00

We also stock new and used ultrasonic cleaners.

Minimum order \$25.00. We pay shipping.

C.E.C.

Cost Effective Components
P.O. Box 1965, Burlingame, CA. 94010
415/344-6383

For More Details Circle (12) on Reply Card

TIPS FOR MOUNTING MATV TAPS

By James E. Kluge, *Technical Editor, Winegard Company*

Some technicians find the mechanical parts of MATV installations to be more difficult than the wiring. These suggestions about the methods and materials used for mounting taps should minimize the problems.

Fig. 1 Plaster rings probably are the best choice when a box is not required, and the rings can be nailed to studs before the sheet rock is installed. This ring is a Raco 772.

Fig. 2 These pictures show the inside and outside appearance of a plaster ring after a Winegard tap has been installed.

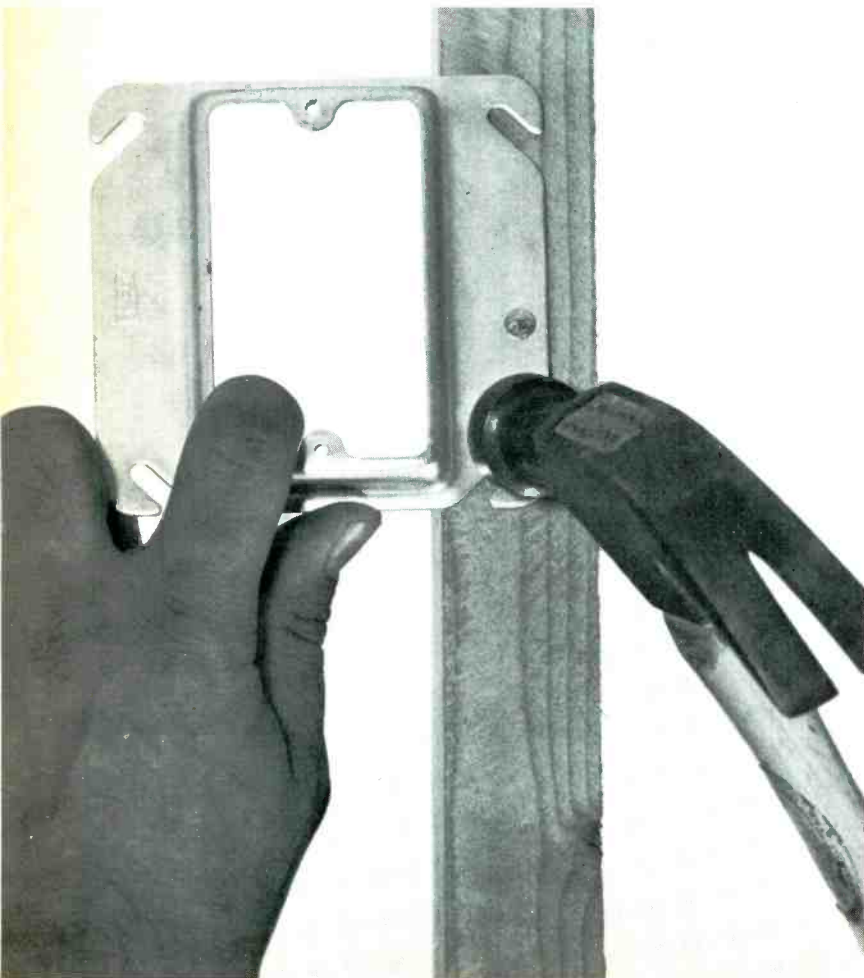
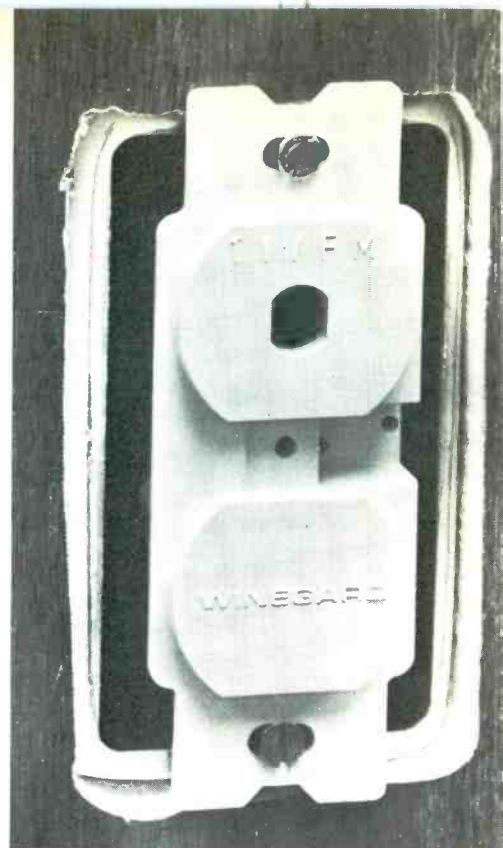

MATV system installations require more wall taps than any other kind of component. Of course, each tap must be attached to a wall, or held in position by some means. Usually the mounting devices are: electrical switch or outlet boxes; "plaster rings", plaster straps; or surface-mount boxes. Many of these are the same as the ones used by electricians for duplex outlets. Also, the locations of the wall taps are similar to where AC outlets are placed.

But, regardless of the similarities, you should learn the important differences before you install any wall taps.

Building Codes

The electrical section of the local, state, and national building codes should be studied so you'll know things you should do and not do when installing taps and running cable that has voltage on it. Sections of the mechanical or structural code might be of secondary interest in guiding you where to drill holes, cut openings, route cable, or mount boxes. If you still have questions, call the city or county building department and talk with a building inspector.

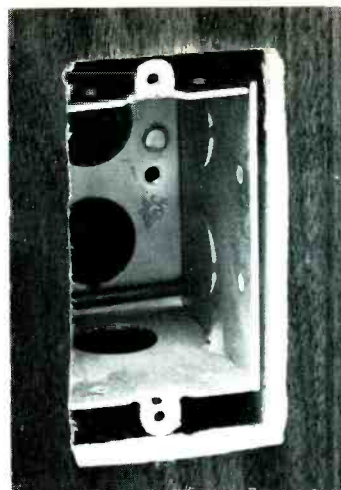
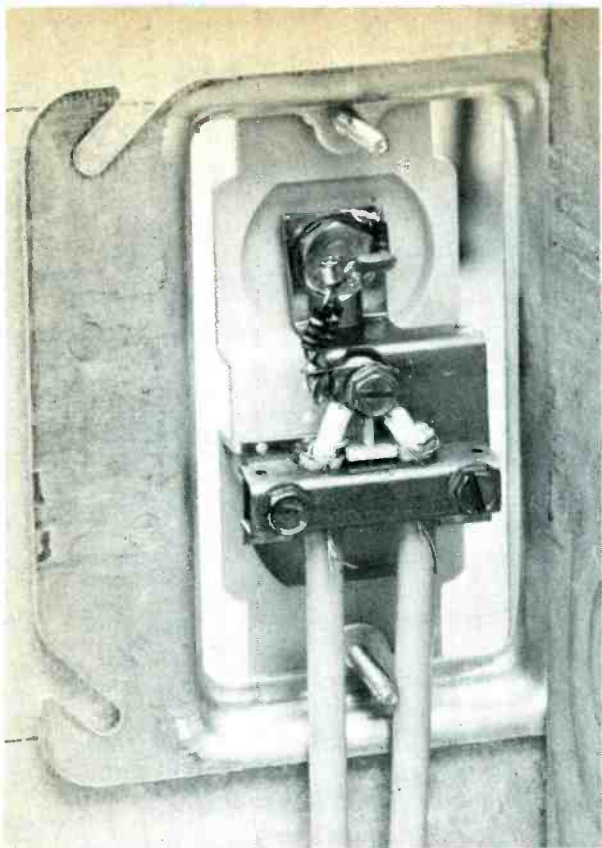

Fig. 3 This steel outlet box has been roughed in, and is ready for the cable and tap. Large 16-penny nails go through the box and into the wood stud for a strong mounting. The knock-outs have been removed to make the cable installation easy.



Fig. 4 Plaster straps are best for use on wallboard that's already there. Two strips at the top and two at the bottom clamp the wallboard between them when the screws are tightened. No stud is required.

Not only can this kind of advance information save you time and money during installations of MATV components, but also it might prevent much expensive rework from work not approved because it was not in compliance.

MATV Is Low Voltage

Where the voltage applied to an MATV cable does not exceed 24 volts, the National Electrical Code rates it as "low voltage", and the coax cable does not require installation in a metallic conduit.

However, in poured-concrete construction, conduit **must** be used, and the boxes will have been installed before the concrete is poured. It is necessary for the cable to be pulled through the conduit in those cases.

Plaster Rings

With woodframe construction, "plaster rings" are the fastest, cheapest, and easiest to install (Figure 1). They can be nailed directly to vertical wooden studs. After the wall board has been installed and the opening cut out, they are ready for the tap and the cable, shown finished in Figure 2.

Some local codes require the tap

to be enclosed within a metal or nonmetallic box. Several types that fulfill the requirement are available (Figure 3). Some boxes have brackets attached to the side for nailing to the studs, or for attaching to the prefab steel studs found in some commercial construction.

MATV boxes usually are not ganged together, as is common with electrical work.

Taps In Finished Walls

Frequently, MATV systems are added to existing homes or apartments where sheetrock or other wallboard has been installed before. In such cases, the box or attachment device must be installed through a cutout in the wall material. For example, a "Tiger Grip" cut-in box is inserted through the opening, and the side brackets are screwed up against the inside wallboard surface, while the top and bottom brackets bear against the outside surface to prevent the box from being drawn in through the opening.

If a box is not required, plaster straps are easily installed in the opening (Figure 4), and the tap attached to the straps.

For both these methods, the wall

opening must be cut out very carefully.

In case wall cut-outs are not permitted, surface-mount boxes (such as Winegard SM-1 or Wiremold 5747S) can be installed with the cable running along the baseboard or the ceiling. Where black-jacketed cable would be too conspicuous, use light-colored (beige) cable, that's available from several manufacturers.

Where To Buy

All of these boxes and plaster rings can be purchased from most electrical supply houses, or hardware stores that carry a large line of electrical supplies.

Plaster rings are available with the device-mounting surface raised 1/4", 1/2", 5/8", 3/4", 1" or 1-1/4" high. They usually can be found in either metal or plastic. Of course, steel is more durable for nailing.

Surface-mount boxes are sold by MATV-equipment distributors. Sometimes, plaster straps are supplied with the tap-offs. They are preferred when one or two taps are added to existing wiring, while plaster rings mount faster and are more reliable for new construction. □

INSTALLING CB ANTENNAS ON DIESEL TRUCKS

Good electrical grounding, neatness, and solidness are essential for a professional installation of CB antennas, especially with large trucks. These profitable installations don't require you to have an FCC license, either. By Forest H. Belt

Visit any busy truck stop and look at the CB antenna installations. Many of them are a mess! Two bad practices show up in most installations done by truckers (and occasionally by technicians) who don't understand CB principles.

Improper mountings

Often you see antennas clipped or clamped haphazardly to side mirrors. In a typical "quickie" job, vise-grip pliers clamp the antenna mounting bracket to the mirror bar.

Not only is this a poor practice mechanically, but it soon damages the mirror bracket, starting rust and corrosion which eventually will destroy the efficiency of the cable ground. You probably know how important a "reflected dipole" is to any quarter-wave whip antenna. Without proper grounding, half the antenna system is lost.

Damage from such crude workmanship prompts some truck companies to forbid CB radios in their vehicles.

Poor cable runs

Antenna cables many times are run through windows or doors. It looks sloppy, although the truck is not damaged. The trade-off is damage to the coaxial cable itself.

Eventually a door or window will be shut against the cable, forcing the stiff center conductor to cut into the soft inner insulation. This spacing between center conductor and shield is critical for correct cable impedance. So, the amount of radiated signal is weakened as the center wire is moved progressively nearer the shield. Eventually a short develops, and the radio



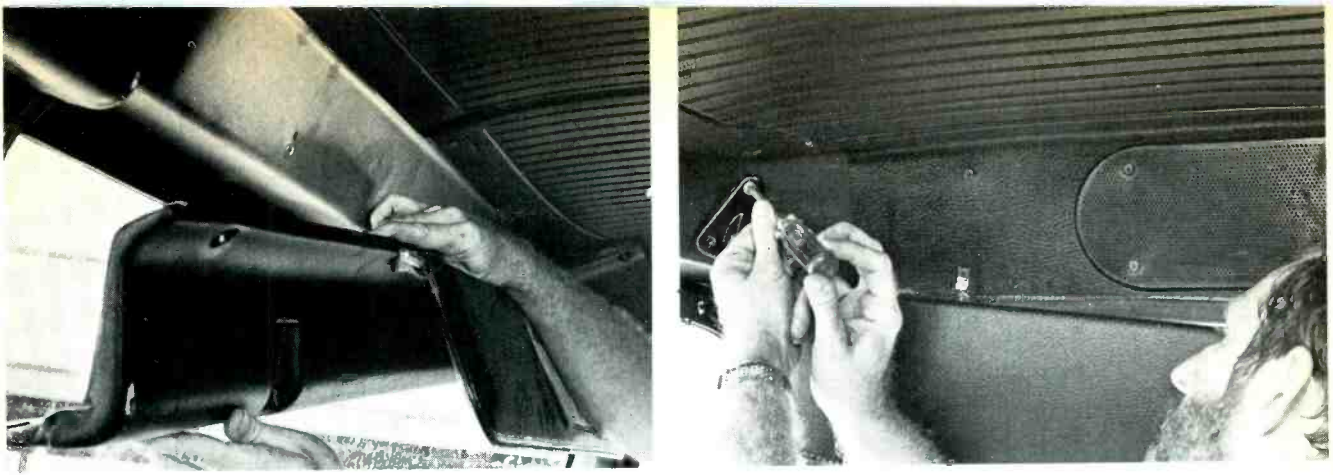

Fig. 1 Padding covers the access holes in the hollow crossbeam above the windshield, and it must come off before you can remove the visors. The side access holes are exposed when the visor bracket is removed.

becomes almost useless.

No Grounds

Another antenna problem on these large trucks (often overlooked even by experienced technicians) comes from the vibration dampers on some side-mirror brackets. To reduce mirror shake from engine vibration and road shocks, some brackets have rubber dampers between mirror and hanger. Those dampers can ruin the cable grounding. When that happens, the unfortunate trucker can talk only a mile or so, and wonders why. He might even buy a black-market linear amplifier in a futile attempt to increase the distance covered. Of course, more transmitting power doesn't help during receiving, which also is impaired when the antenna system is not efficient.

Intermittent or high-resistance connections also can occur between the door and the body of the truck. Usually the greased hinges are the culprits. This is not as serious as a lack of ground at the antenna bracket, but it does affect the performance.

Plan The Installation

Of course, it's better to prevent problems of poor grounds and cable damage, rather than be forced to cure them later. Planning is the answer; study the installation before you begin it.

I hope you followed my suggestion of last month and learned from a dealer some of the details of construction in the truck you're about to tackle.

In particular, consider the cable configuration of the dual antenna you've decided to install. (Duals

add range to CB communications, if properly installed, and are popular with truckers.) Why study the cable? It determines where you begin the installation.

Two types of cable arrangement are common with dual antennas. One kind has a separate cable all the way from each antenna to the RF connector at the transceiver. Both cables are RG-59/U coax, rated at 72-ohms impedance. Lengths are critical; you should not cut these cables. The antenna manufacturer wires the two cables together in parallel inside the PL-259 RF connector at the radio.

Because the two cables are already wired together permanently (reinstalling a connector on these is a job to avoid if possible), you always begin the cable run at the transceiver. For part of the way, you might route the two cables together. Sooner or later, however, one must veer off toward the right antenna and the other toward the left. Consider carefully the best place to separate them.

The other kind of dual antenna cable incorporates a "T" configuration. A single noncritical length of 50-ohm RG-58/U coax runs from the transceiver connector to a junction. There, the manufacturer has joined the RG-58/U to two critical-length sections of RG-59/U. One goes to each antenna. Typically, you begin this kind of antenna cable installation at some point that permits the RG-59/U branches to reach their respective antennas conveniently.

One Example

For demonstration, I've selected the **Antenna Specialists Model M-**

315 "Minnie Momma" pair, and I will install them on a GMC **Astro** road tractor. With these antennas and this truck, the best place to start proves to be at the center of the hollow above-windshield crossbeam. You'll see presently how to bring the cables to each antenna.

An alternative, possible with some tractors, will be to begin the cable run at the base of the windshield, under the console cover, in the vicinity of the power panel. But some tractors don't offer access through the doorposts and doors as easily as others. Also, with some "T"-arranged cables, branches from the junction to the antennas may not be long enough for easy lead dress through the doors.

So, with the antenna package opened, here's how you proceed. Remove the padding above the windshield, as Figure 1 illustrates. Dismantle the visors. This uncovers the center access hole in the crossbeam, and the two small holes behind the visor mountings. Some trucks have access-hole covers easily visible above the windshield; others have them over the doors.

Poke the cable junction into the center access hole (Figure 2), and enough extra to hold the cables there. Slip the end of the 50-ohm cable—the RG-58/U—from inside the crossbeam down through the hole occupied by the AM radio lead-in (most trucks have one). There should be no PL-259 connector on the CB cable; if there is one, cut it off. Dress the RG-58/U behind the metal protector strap, as the photos show.

Lined up with the windshield post, drill a hole (half-inch size) in the console edge. Install a grommet

(the heavy-duty size are called rubber bushings in hardware stores). **Be very cautious in drilling.** Air conditioner hoses and other wires may be situated beneath this forward roll of the console. Drilling into them could be costly. Feel exactly where you plan to drill. Move things out of the way if you must.

If the windshield post is hollow, as in some trucks, you can remove the cover and bring the RG-58/U down inside the post; the cable is stiff enough to fish out below without any problem. For the GMC in my example, your best alternative is to flip the AM radio cable out of the channel it snaps into, and tape the CB antenna cable to

the AM cable. A few turns of black tape in two or three places will hold it easily. Then just snap the AM cable back into the track where it belongs.

Poke the tip of the CB antenna cable through the grommetted console hole. Pull all the excess cable down, leaving a gentle slope between windshield post and console.

Carry the cable end over to the grommet near the transceiver (last month's article). Poke the end up through that grommet. Pull through enough cable to reach the rear of the transceiver with 4 or 5 inches left over (Figure 3); you'll use 2 or 3 inches when you install the PL-259 connector. Bundle the leftover cable beneath and inside the console, and secure it with a cable tie.

Now install the PL-259 connector or a solderless equivalent. (I demonstrated how in the September 1975 issue of *ELECTRONIC SERVICING*.) I prefer soldered connectors for truck installations, where the driver is likely to be taking the unit out frequently.

About half an hour should be required to reach this point of the antenna installation.

Drilling Into The Cab

Before you fish either antenna leg of the coaxial cable across the "tunnel" above the windshield, drill the entry holes in the truck skin. Situate them near the access holes at the corners. The easiest way to locate them correctly is to insert the centerpunch into the access hole (Figure 4), and tap it a sharp blow with a hammer. This bulges the skin so the spot can be seen from the other side.

Then climb up on a ladder outside, centerpunch a deep dent to keep the bit from wandering, and drill the hole. Repeat the same procedure for the other side of the truck.

A half-inch hole accepts a thick grommet having a quarter-inch center hole. You can buy such grommets at electronics stores; however, I find better ones in hardware stores, where they are called "rubber bushings." They're thick and heavy duty, making them suitable for long life in a truck installation.

Figure 5 shows how easy it is to fish each leg of the antenna cable

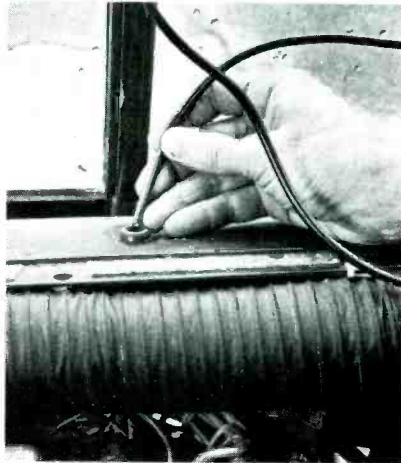
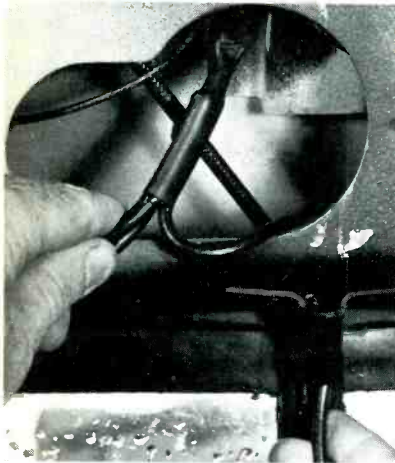

Fig. 2 Always begin any dual-antenna cable run where the two cables from the antenna join. Tape the cable to the AM-radio lead-in, then insert it through the grommet you have just installed in the console.

Fig. 3 Remember to run the cable end through the grommet from below before you install the RF connector at the radio transceiver. Excess cable inside the console should be secured with cable ties.

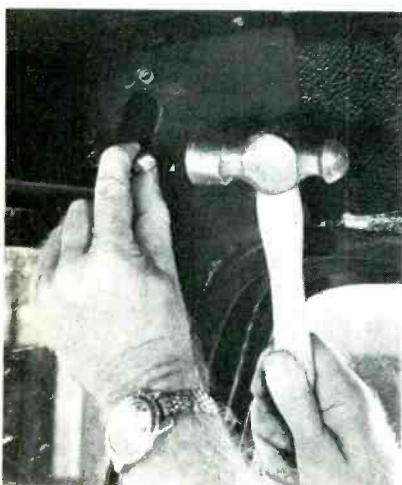
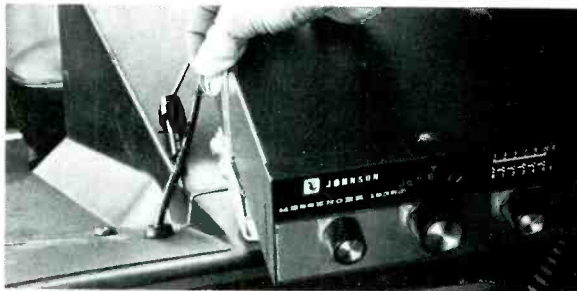

Fig. 4 Mark the spot for the hole (needed to bring the cable to the outside) by denting the roof with a centerpunch inserted in the access hole from the inside. Then, on the outside of the cab roof, centerpunch near the dent, and drill the 1/2-inch hole.

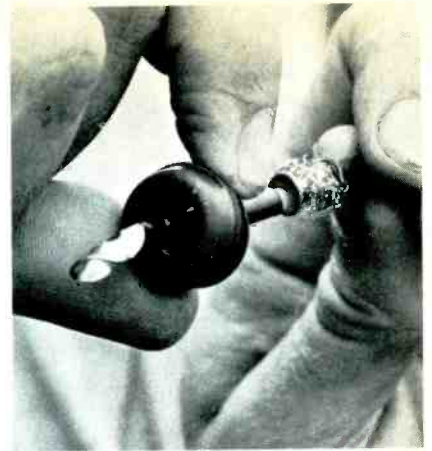

Fig. 5 RG-59U cable is stiff enough that a fish tape should not be necessary to pull the cable through the tunnel over the windshield. Don't forget the grommet for the outside hole.

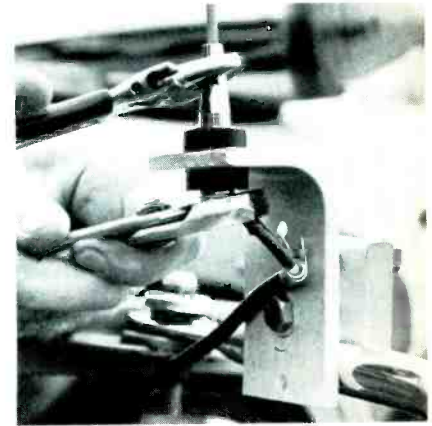
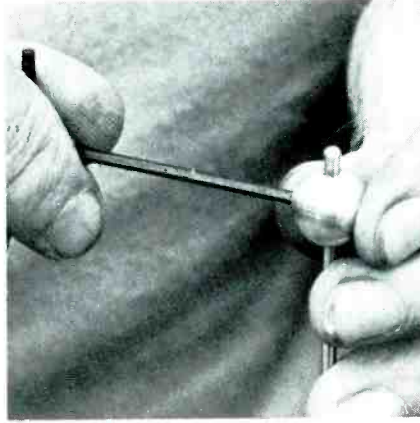
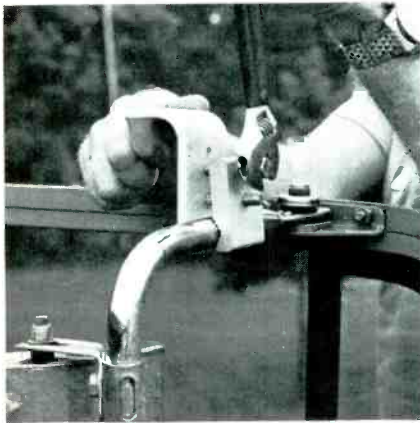

Fig. 6 Mounting bolts for the antenna bracket must be tight, but not tight enough to crush the mirror frame. Set the tuning adjustment (ball or rod position) to the average point recommended in the instruction book. Assemble the cable lug, insulators, antenna, and the bolt. Then tighten the bolt.

across the hollow crossbeam. Just push the cable into the center access hole. When the end, with the terminal lugs, comes into reach at the corner hole, pry it out with a finger. Other kinds of crossbeam construction make the job just as simple.

(Alternately, if you're bringing a cable across the console to a doorpost, you'll find the doorpost is hollow, too. Usually removing a narrow covering gives access. You then fish the cable end out a doorpost hole about halfway down the kick panel. A hole in the door near the hinge, and an access plate up near the window vent, permit you to bring the cable up to an outside entry hole you drill in the door skin near the bottom of the mirror bracket. Be careful when drilling. Don't get tangled up with the window-lift mechanism.)

Once you get hold of the cable end, you can push it outside through the corner entry hole just

drilled. Slip a grommet over the lug on the end of the cable. Work the grommet into the entry hole. Use a screwdriver, but don't puncture the wall of the grommet.

Next, fish the second cable across to the other side, push the cable outside, and install a grommet. Pull out enough length of each cable to reach the mirror bracket, where the antenna bracket will be located.

Mounting The Antenna

Mounting the antenna consists entirely of common-sense mechanical steps, as shown in Figure 6. Don't tighten the mounting bolts enough to mash the steel piping of the mirror frame. That would weaken the mirror and crack the chrome plating, allowing rust. Any good type of mounting clamp, such as the wide-base one pictured here, grips securely without excessive tightening.

Before assembling the antenna rod, you should check the instruc-

tions to see how the antenna tunes. The antenna I'm using here has a sliding top-cap ball near the tip of the antenna rod. You'll tune the antenna later, so for now just place the ball on the rod within a quarter-inch of the end, and tighten the setscrew. Some center-loaded or bottom-loaded antennas are tuned by sliding the antenna rod into or out of the loading coil.

Now, assemble the base insulators in the mounting bracket. Insert the base bolt through the large lug on the end of the antenna cable. (If you bent the lug so it would go through the grommet, flatten it.) Push the bolt up through the insulators and screw it into the antenna rod. Tighten the bolt, but apply only enough pressure to make the installation solid. Leave the antenna cable slightly loose for the next step.

Make sure the grounding clamp surrounds and traps the shield strands between itself and the end

Fig. 7 Solid grounding is imperative, for both cable and mounting bracket. Otherwise, the metal truck body cannot serve as the other half of the "dipole", increasing the VSWR and weakening the output power.

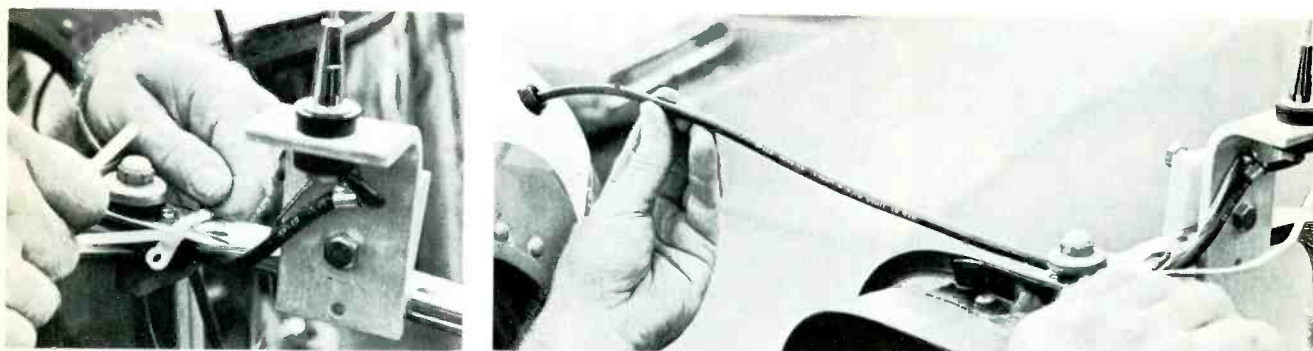
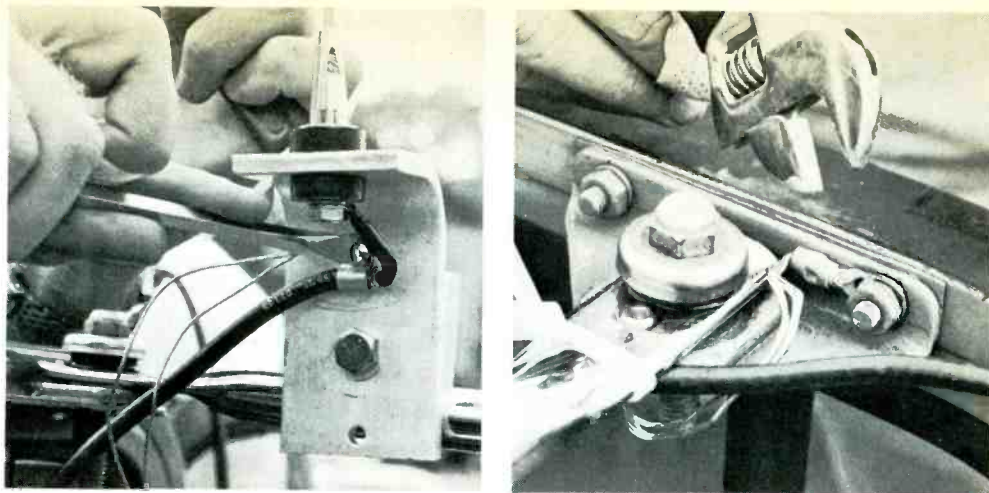

Fig. 8 Use a plastic tie to secure the coaxial cable, even when the cable goes direct from the antenna to the top of the cab. The final step, after you have opened the door to determine how much slack is needed, is to apply sealer to keep moisture from entering through the grommet.

ferrule. While you're at it, install a 6-inch strip of metallic braid or heavy stranded copper wire on the same bolt that holds the grounding clamp. Figure 7 shows how. This is to ground the antenna mount through the braid or wire to the door frame, bypassing the vibration dampers of the mirror. Scrape away any paint from under the bolt that grounds the braid. Use a spade lug on the braid. This bond is crucial to give proper loading of the antenna.

To relieve strain on the ground and center connections of the antenna cable, install a cable tie firmly around the cable and the mirror-bracket pipe near the door edge (Figure 8). Clip off the unused end of the cable tie.

Open the door to its widest, making sure you leave enough (but no more than just enough) slack so the cable doesn't slide in the grommet when the door is opened or closed. Push any excess cable back inside the cab through the grommet.

Go to the other side and com-

plete the mounting and hookup of the other antenna, using the same method.

Finally, clean thoroughly around the grommets. If there's any dampness, dry it. Then seal around the cables and the edges of the grommet using windshield sealer (buy it at any auto-parts store). Let the installation wait an hour or so, and spread another coating of sealer over the cables and grommets. It's important that water is prevented from following the cable inside.

Reinstall the sun visors, and the above-windshield padding. Connect the PL-259 cable plug to the radio transceiver, and you're ready to see if the rig works.

Testing And Tuning

Connect a Voltage Standing-Wave Ratio (VSWR) meter, key the transmitter, and calibrate the meter for forward power. Then select reverse-power measurement, and key the transmitter again.

If the cable, connector wiring, and grounding are all okay, you should find little reflected power.

VSWR reading should be no higher than 1:1.5 on the meter (the lower the second number, the better). With most dual-antenna installations, 1:1.2 is considered to be excellent. But 1:2 or worse usually signifies poor grounding, a faulty connection, or a badly-mistuned antenna.

Antenna tuning should be done with a field-strength meter used as an indicator. Some technicians go by the power meter on the transceiver, but that's a poor practice. Instead, tune for the strongest power radiated to an external field-strength meter. Then check the VSWR again. If the VSWR is high following tuning, hunt for a fault in the antenna system. (Hint: the most common defect is a poor soldering job in an RF connector.)

Remarks

Install a few antennas the professional way with careful workmanship and neatness, and you will be established soon as **THE** technician for truck CB installations in your area. □

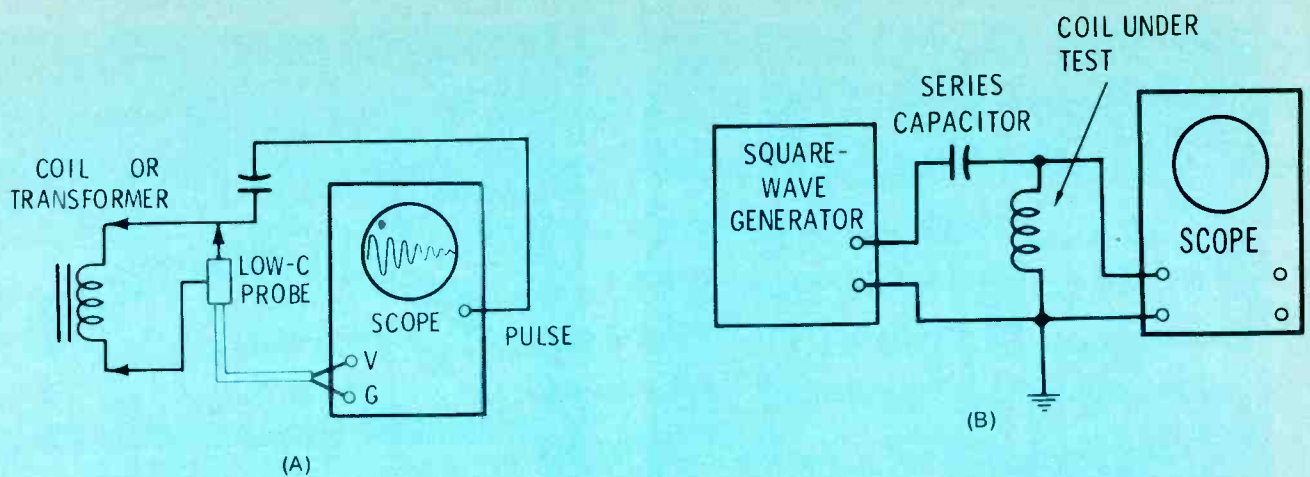
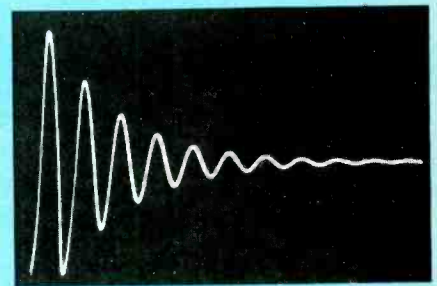

Fig. 1 These are older methods of ringing sweep inductances, using a scope for readout. (A) Obtaining pulses from the scope for ringing provides automatic locking, but doesn't give exact frequencies. (B) Ringing from square waves gives precise frequencies, but requires more equipment. (C) Ringing an inductance produces a damped sine wavetrain. Higher "Q" extends the time the ringing continues; lower "Q" reduces it.



(C)

Reports from the test lab

By Carl Babcoke

Each report about an item of electronic test equipment or a component is based on examination and operation of the device in the ELECTRONIC SERVICING laboratory. Personal observations about the performance, and details of new and useful features are spotlighted, along with tips about using the equipment for best results.

Ringling Tests

For years, many technicians have placed great faith in "ringing" to determine whether or not a yoke or transformer winding had shorted turns. Resistance tests are almost infallible in finding open windings, but a few turns shorted doesn't reduce the reading enough to be significant. Inductance measurements are not practical, outside of laboratories.

Previously, ringing tests solved these problems while adding a few of their own. For example, the theory behind ringing is that a parallel-tuned circuit (capacitor

and coil), when hit with a steep, narrow waveform, will produce a damped wavetrain of sine waves (the amplitude gradually diminishes because of losses). The usual method is to extract pulses from the horizontal sweep circuit of a scope and feed them through a capacitor to an inductance. The vertical amplifier of the scope is connected across the inductance to show the ringing that resulted (Figure 1A).

However, there were problems. One was the inconvenience of hooking up a scope each time. Even worse was the difficulty in knowing what frequency was needed, and how to be certain you had obtained it. That's because recurrent-sweep scopes are not calibrated.

Square waves can ring inductances (Figure 1B), and the generators have known frequencies and good stability. But that solution adds another large item of test equipment.

However, after all the trouble

and equipment, the ringing-test waveforms (Figure 1C), could prove even one shorted turn (if tested against a known-good component).

So then, ringing tests are excellent when everything goes well, but there are many aggravations and chances for errors. At least that was the situation before Sencore introduced RINGER Yoke And Flyback Tester, which rings inductances with narrow pulses, counts the number of ringing cycles, and shows the count on a calibrated meter. Thus, one item of equipment does the entire test. But YF33 does more. Provisions are made for measurements of DC focus voltages, high voltages, and peak-to-peak drive voltages in two ranges.

Ringling With YF33

Operating the Model YF33 RINGER is as simple as making a reading with a VOM. Inside the compartment at the bottom is the AC cable and two permanently-attached flexible leads with clips

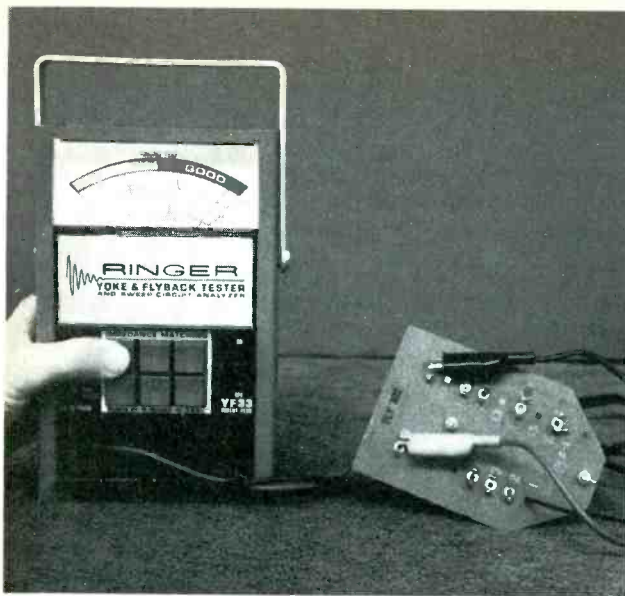

Fig. 2 Only two test leads of the Sencore YF33 RINGER connect to the component or circuit being checked.



Fig. 3 Six "impedance matching" pushbutton switches select the value of internal capacitance giving the most cycles of ringing. (The numbers are not on the RINGER; we added them to the picture for identification.)

and insulators. With the TV set power turned off, just attach the clips to the proper points of the component or circuit (see Figure 2). Turn on the RINGER, push down the RINGING TEST button so it latches, and depress (one at a time) the six IMPEDANCE-MATCHING buttons (Figure 3), noticing which one gives the highest reading on the meter (Figure 4). That button is the one used to judge the condition of the inductance.

The matching buttons have two functions. Pushing any one connects the output of the pulse generator to the test leads and also parallels a

capacitor to tune the inductance for the highest number of rings before the output drops below the 25% level. For example, the button we have labelled #1 connects a 47 picofarad, and #6 parallels a .15 microfarad, with the others in between.

At the top of the meter face is a GOOD-BAD calibration. That's just a reminder, or something to show the customers. Underneath is a scale marked CYCLES with numbers from zero to 60. This is the number of cycles of sine wave occurring under the conditions established by the tester. After you

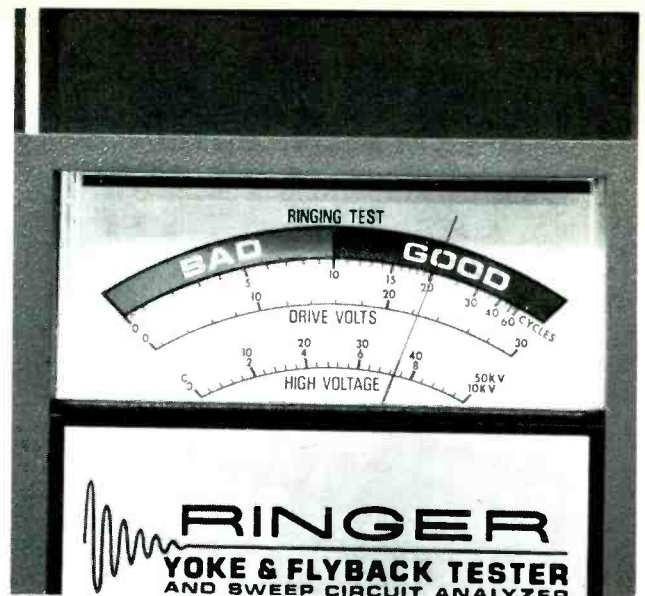

Fig. 4 Although the meter face has a "bad-good" scale, you should usually go according to the "cycles" scale just below it. Not all coils or transformers are good above 10 cycles; nor are all circuits necessarily bad below 10 cycles.

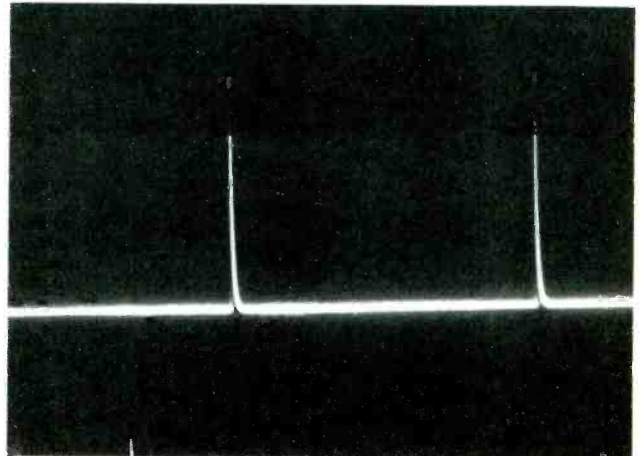
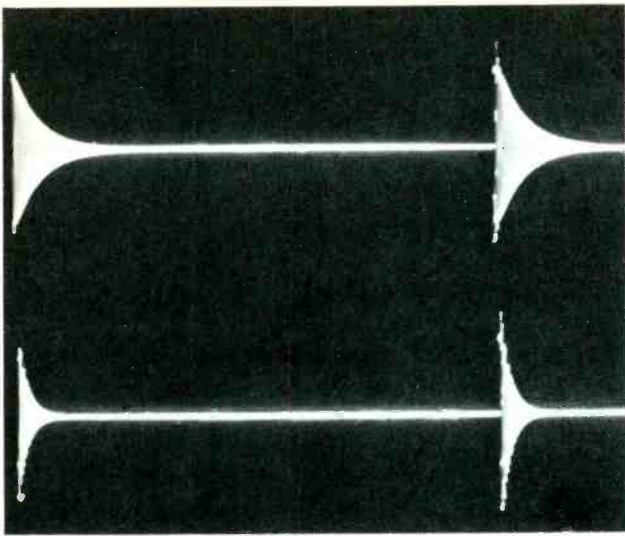

Fig. 5 Narrow 120-Hz pulses are applied to the tuned circuit consisting of the external inductance and an internal capacitor (selected by the matching buttons), causing the circuit to ring.

have some experience at interpreting the readings, you will know whether the component can be judged now, or if more tests are required.

Waveforms And Results

Figure 5 shows the sharp, positive-going pulses at the test leads when there's no inductance connected. (These pulses are fed to the inductance through a diode that acts as a gate, closing during the pulse time. Therefore, a 100K resistor was connected across the test leads so the diode would conduct and furnish the pulses.)



(A)

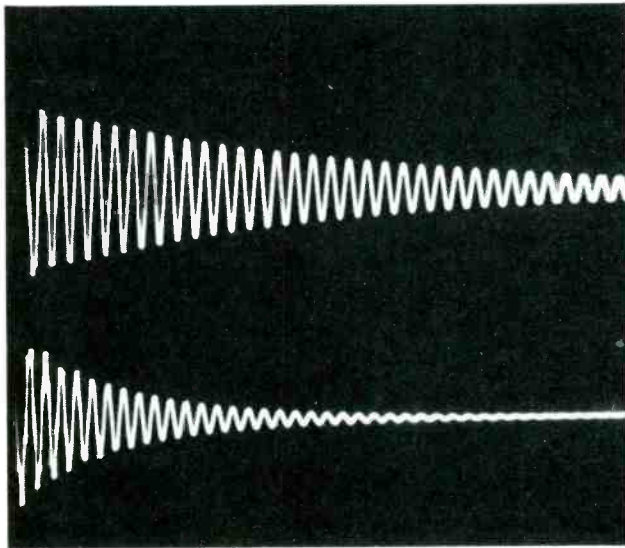

(B)

Fig. 6 (A) Top waveform shows the ringing produced by two pulses applied to a normal flyback (button 1, reading of over 60 cycles). Connecting together the two leads of the rectifier filament shortened the time of ringing (bottom trace), reducing the reading to 23 cycles. (B) These are the same as in (A), except the first bursts of ringing were stretched by viewing them on a triggered scope.

Repetition rate of the pulses is very low compared to older methods of ringing. A sample of the 120-Hz ripple from a power supply is used as the source for an IC stage that shapes the ripple into the narrow pulses. Therefore, the frequency is very stable.

The low-repetition rate results in damped wavetrains with considerable space between them (Figure 6). However, the circuit charges a capacitor by integration, and the capacitor holds the charge (reading) until the start of the next pulse, when it is discharged and made ready for the next burst of ringing.

So the wide spaces have no effect on the readings.

Figure 6 also shows normal ringing waveforms and the change produced by shorting the two-turn rectifier filament winding (to simulate shorted turns). The normal reading of the out-of-circuit flyback was 60 on button 1, which dropped to 23 when the leads of the filament winding were shorted together.

On the meter face, 10 cycles of ringing marks the dividing line between bad and good. Yet, out-of-circuit flybacks often will test more than 10, even when severely shorted. That's one of the times experience

and discretion must indicate an exception is needed from the 10-cycle rule. Another factor that affects the inductance (although not a limitation of the RINGER) is the presence of metal around the flyback. For example, the reading of 60 decreased to 40 when the flyback was lying on a metal bench.

An old yoke from a tube-type color receiver checked 35 on button 3, for both horizontal coils, and 29 on button 3 for either coil alone. The paralleled horizontal coils of an RCA XL-100 gave 27 rings on button 3.

Waveform difference because of

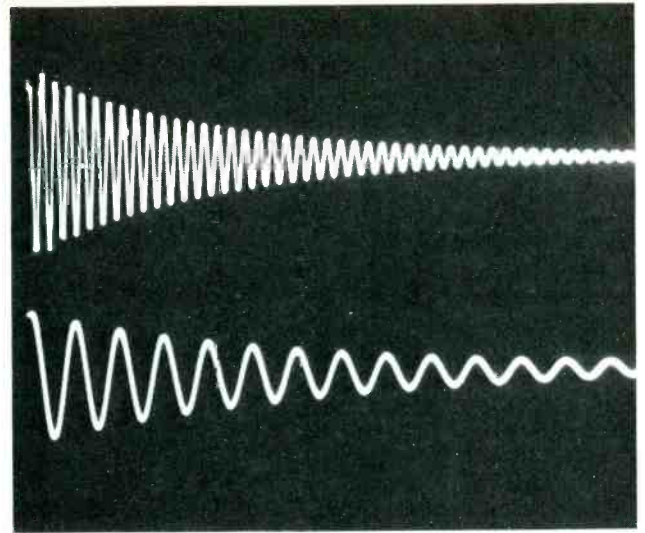

Fig. 7 Scope adjustments and flyback are nearly the same as for Figure 6B, except the top waveform shows the 41 rings with button #3, and Button #5 gave the 17 rings of the bottom trace.

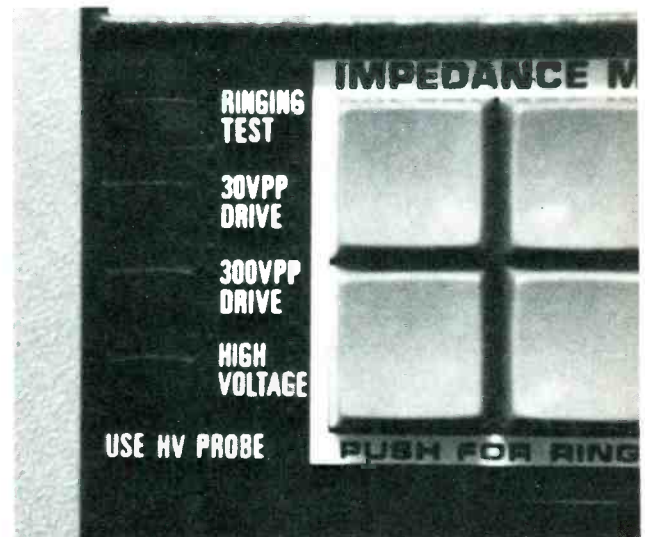

Fig. 8 Smaller pushbuttons to the left of the large matching buttons select ringing, two ranges of peak-to-peak voltmeter ranges to measure drive, and focus or high voltage DC measurements with external probe.



Fig. 9 The black probe (nearest the camera) enables the YF33 to measure up to 10-KV DC, while the larger red slip-on probe extends the range to 50-KV full-scale.



Fig. 10 The meter is protected by a sliding lid, and the power cable and test leads are behind the compartment door at the bottom, when the RINGER is stored or transported.

different matching buttons is shown in Figure 7. Top waveform is an expansion of button 3 on the flyback, and represents a 41 reading. Button 5, with a reading of 17 rings, is shown by the bottom trace. Larger capacitances ring the inductance at a slower number of cycles before the amplitude drops below the cut-off point of the instrument. There is an adjustment for this cut-off point, and the operating manual gives a method of changing the calibration to accommodate any exceptional cases. Personally, I believe the calibration should be undisturbed, and mental allowances made for the unusual cases.

Incidentally, Sencore says it might be interesting to look at the ringing waveforms (as we have done here), but they don't recommend it as a usual practice. For one thing, it cancels some of the time you save by using the RINGER, and the added capacitance does change the readings slightly.

Other Functions Of YF33

To the left of the six matching buttons for ringing, are four small pushbuttons (Figure 8). They are labelled: from the top: ringing test; 30VPP drive; 300VPP drive; and high voltage. The two for drive are to measure vertical or horizontal drive voltages, and are calibrated for 30 volts and 300 volts peak-to-

peak full scale. The same two leads are used for these measurements.

Figure 9 shows another option, the ability to measure focus voltages up to 10 KV using probe FP201. Probe 39G89 slips over the end of the focus probe to change the full-scale limit to 50 KV. These probes are to be used **only** with the RINGER. Resistors inside the unit prevent arcs or shocks if the ground lead falls off during a measurement.

The RINGER closes up completely for storage or for transportation (Figure 10). A sliding lid covers the meter face, and a compartment at the bottom holds (but just barely) the flexible leads and the heavy-duty power cable.

Summary

Sencore's YF33 RINGER operates easily and accurately, because of a fixed pulse repetition frequency and a **meter** readout of the number of rings. I have made many ringing tests over the years, but they involved experimenting to find the optimum value of capacitor, while hoping the scope frequency was right for the component. Probably the uncertainty of what the scope waveform indicated was the worst drawback. For example, a flyback might be so defective the high voltage was killed. Yet, it could be **forced** to ring enough to fool a technician, given an unlucky choice

of adjustments. Direct comparison with a known-good component was required for accurate results.

The RINGER can answer more questions about the condition of a sweep inductance than can any other item of technician's equipment. However, **no machine** can indicate the difference between a non-defective low-"Q" inductance and a high-"Q" type that has a few shorted turns. That's where your experience and common sense must qualify the meter reading.

One valuable shortcut is to attach the RINGER to ground and to the plate cap of the horizontal-output tube. Of course, the reading of a normal circuit will be lower than that of a flyback alone. But how much lower?

Vertical-yoke coils can be rung (it's best to test each separately), but the damping resistors first **must** be disconnected, or you'll get no reading. Tests of vertical-output transformers are supposed to be possible, but I haven't found any during the testing time of this report that read in the "good" area of the meter.

Most of these variations from the average are discussed in the operating manual for the RINGER. But manuals start with the average conditions, and the exceptions are found in the back of the book. So, be certain you read the entire manual. □

Circuit Saver™ kit includes two sizes of tiny drill bits, two sizes of burs (countersinks), and two adjustable handles.

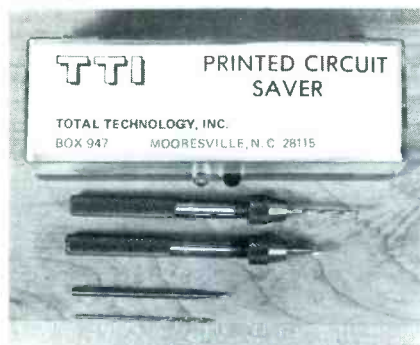

With a bit chucked in a handle, the device can be rotated by fingers, cleaning the hole. If desired to use a replacement part with larger lead wires, use the larger bit or burr. Also, the bits can drill new holes in boards, for modifications.

For More Details Circle (28) on Reply Card

Liftgate Dolly

Pushbutton controls at the handle permit the lead-screw to raise the wheels and base plate alternately of the Lectro-Truck machine, which is a combination dolly, liftgate, and stair-climber built by Woodward.



Accessories include a recessed hook box to be mounted on the floor of the truck, and a fold-under metal platform for trucks with high-level decks. One-man deliveries of appliances or TV's can be made without lifting.

For More Details Circle (29) on Reply Card

Write and tell us what kind of articles you would like to see in **Electronic Servicing**

Help your Heart... Help your Heart Fund



American Heart Association

Free Stapler



When you stock up now on Perma Power Color-Brites... the serviceman's staple.

For a limited time, you can save \$4.65 on a four-pack of Perma Power Model C-511 Color-Brites. And the stapler is our gift!

Perma Power Color-Brites are among the staples of your business. Model C-511 fits most color tubes. Easy to use, it plugs right in, instantly restores faded color, contrast and sharpness to the older color television picture tube, extending useful life a full year or more! And your customer will remember you happily when replacement time comes.

Check your stock of Perma Power Color-Brite, while you can buy this serviceman's staple at savings of \$1.16 per britener. Hurry, supplies are limited, so see your distributor today.

Perma Power® Color-Brite

A PRODUCT OF
Chamberlain

Chamberlain Manufacturing Corporation
Perma Power Division
5740 North Tripp Avenue, Chicago, Illinois 60646
Telephone: (312) 539-7171

For More Details Circle (13) on Reply Card

test equipment report

These features supplied by the manufacturers are listed at no-charge to them as a service to our readers. If you want factory bulletins, circle the corresponding number on the Reply Card and mail it to us.

CRT Tester/Restorer

RCA's "Simul-Test" system is used in Model WT-333B, which tests and restores all types of b-w and color picture tubes.

Three meters allow the testing of three color guns simultaneously for emission, emission tracking, and internal shorts or leakage. These tests are said to simulate actual operation in television receivers. The shorts-removal does not endanger the tube, and "auto-timed" and "ranged" renewal of the emission minimizes the possibility of tube damage. Heater voltage is measured at the pins of the picture tube, and the power-line voltage can be measured on a separate scale.



Four tube-socket adapters, covering 90% of the b-w and color picture tubes currently in use, and a simplified set-up chart for 2000 different types are supplied. Nine additional adapters are optional.

WT-333B tester/restorer sells for \$249.90 each.

For More Details Circle (30) on Reply Card

APPLIANCE REPAIR BOOKS

Written in easy-to-understand language by experts with illustrations & diagrams. Acclaimed by instructors & professionals. How to diagnose & repair air conditioners, refrigerators, vacuum cleaners, ranges, washers, dryers, steam irons, portable kitchen appliances, water heaters, plus how to set up a shop, using test instruments and more. Only \$2.65 to \$4.90 each!

SEND FOR FREE DESCRIPTIVE PRICE LIST

C & N, DEPT. ES, 5841 MONTRÖSE, CHICAGO 60634

For More Details Circle (14) on Reply Card

Junction Tester

In-circuit or out-of-circuit dynamic tests of the junctions of diodes and bipolar transistors can be made by connecting the "In-Circuit Tester" (manufactured by the Barber Corporation) to your scope.



A perfect diode junction forms a right angle; leakage or circuit resistances open the angle; and capacitances add loops.

For More Details Circle (31) on Reply Card

4-1/2 Digit Multimeter

For higher accuracy of readings, Hewlett-Packard offers Model 3465A digital multimeter, which has 4-1/2 LED digits providing DC voltage measurements of $\pm 0.02\%$ of reading plus .01% of range.

Six DC voltage ranges from 10 millivolts to 1,000 volts full scale permit readings down to 1 microvolt. AC voltage ranges are from 100 millivolts to 500 volts full scale in 5 ranges, AC and DC current ranges are from 100 microamperes to 2 amperes, and the 6 resistance ranges are from 100 ohms to 10 megohms full scale. Open circuit voltage when measuring resistance does not exceed 5 volts.



A standard Model 3465A has an internal AC power supply and rechargeable Ni-Cad batteries, but other variations eliminate the Ni-Cad batteries, or permit operation with 4 "D" cells.

Price with Ni-Cad batteries is \$500, option 002 with "D" cell batteries is \$425, and option 001 with AC only is \$480.

For More Details Circle (32) on Reply Card

Mini-scope, Counter and DMM

The Vu-data Model PS915/975 combination scope, frequency counter, and digital multimeter has separate displays for each function, and all three can be used simultaneously with one signal or separately. Total size is 3-1/2" high, 8-1/2" wide, and 12-1/2" deep, and the units can operate from 120-volt AC or from an external 12-volt supply.

Model PS915 Mini-Scope (which is available separately) has vertical sensitivity of 10mV/div at 20-MHz bandwidth, single trace, triggered sweep up to 100nS/div (plus 5X magnifier), and external sync or X axis.



The DMM in auto-ranging with a 3-1/2-digit display, and the counter operates up to 20 MHz with a 4-digit readout.

Model PS915/975 scope/DMM/counter sells for \$1,250.

For More Details Circle (33) on Reply Card

FET Multimeter

A large 5-1/2-inch mirrored-scale meter, automatic polarity for DC readings, and six ranges of capacitance measurements are some of the features of the Hickok Model 370 deluxe FET multimeter.

Input impedance is 10 megohms for all AC and DC voltage ranges, and all ranges and functions are selected by pushbuttons. Voltage measurements are in 9 ranges from .15 volt to 1500 volts full scale, and peak-to-peak voltages are from .4 volt to 4KV. Decibels have 9 ranges from -20 dB to +60 dB, with frequency response up to 50 KHz. Eight resistance ranges cover from X1 to X10M, with a choice of high or low voltage (to read or not read diode junctions). Capacitances from .0005 to 10,000 microfarads can

be measured in 6 ranges. Nine AC and DC current ranges use the voltage scales for .15 milliamperes to 1.5 amperes.



An isolation resistor, that does not require a switch, improves the accuracy of DC readings where AC or RF is present. For resistance ranges, a built-in op-amp power supply eliminates batteries.

For More Details Circle (34) on Reply Card

Dual-Trace Adapter

Model WM-541A dual-trace adapter from RCA can be added to any brand or model scope to produce two separate waveforms.

Each channel has a vertical-centering control, a frequency-compensated 6-position attenuator switch, and an AC/DC selector switch. Input impedance is 1 megohm paralleled by 55 picofarads, and the maximum AC input signal is 50 volts peak-to-peak (500 volts PP with an X10 probe). Maximum output is 1 volt PP with less than 10 millivolts of noise.



WM-541A

Either chopped or alternate mode can be selected, and the switching rate is variable to minimize flicker or beats.

The RCA WM-541A dual-trace adapter sells for \$108, and the optional WG-400 direct/low-cap probes are \$15 each.

For More Details Circle (35) on Reply Card

Low-Cost Multitester

Seven ranges of DC voltage with polarity-reversal switch at 20,000 ohms-per-volt and 6 ranges of AC voltage, are featured in the Eico 570 multitester. The versatile unit has 5 DC current ranges to 10 amps, 6 dB

ranges for audio measurements, and 4 resistance ranges to 50 megohms.

The \$49.95 (wired only) multitester includes a two-color extra-large mirrored scale for easy readability, high-impact case, and comes complete with batteries and test leads.

For More Details Circle (36) on Reply Card



EICO Model 570 Deluxe Multitester

FREE ALARM CATALOG

Full line of professional burglar and fire alarm systems and supplies. 96 pages, 450 items. Off the shelf delivery, quantity prices.



mountain west alarm
4215 n. 16th st., phoenix, az. 85016

For More Details Circle (15) on Reply Card

IT'S NO PUZZLE
TO ORDER



OELRICH SERVICE FORMS

FOR TV-RADIO & 2 WAY RADIO SERVICE LEGAL FORMS FOR CALIF. FLA. UTAH NOW AT YOUR PARTS JOBBER OR WRITE FOR CATALOG B64
OELRICH PUBLICATIONS
4040 N. NASHVILLE AVE. CHICAGO, ILLINOIS 60634

For More Details Circle (16) on Reply Card

Please Help Children Live

Life is what St. Jude Children's Research Hospital is all about. This non-sectarian hospital is the largest childhood cancer research center in the world.

Because St. Jude Children's Research Hospital treats all of its tiny patients FREE of all charges, and because of the paramount cost of life-saving research, we must ask for your support.

Please join in the fight against childhood cancer.

Send your special gift now.



Danny Thomas, Founder

**ST. JUDE CHILDREN'S
RESEARCH HOSPITAL**

Send contributions to: MEMPHIS, TENN. 38101

This space donated by publication

The MARKETPLACE

This classified section is available to electronic technicians and owners or managers of service shops who have for sale surplus supplies and equipment or who are seeking employment or recruiting employees.

Advertising rates in the Classified Section are 35 cents per word, each insertion, and must be accompanied by cash to insure publication.

Each initial or abbreviation counts a full word.

Minimum classified charge \$3.00.

For ads on which replies are sent to us for forwarding (blind ads), there is an additional charge of \$3.00 per insertion to cover department number, processing of replies, and mailing costs.

Classified columns are not open to advertising of any products regularly produced by manufacturers unless used and no longer owned by the manufacturer or a distributor.

FOR SALE

DON'T JUNK THAT T.V.—We have the most complete stock of T.V. picture tubes in U.S. B & W and color, old or new, over 1700 types at the lowest prices. ALLIED SALES, Pimento, Indiana 47866. 812-495-5555. 11-75-3t

ADVERTISING PACKAGE FOR TV service shops. Inexpensive eye catching ads contain personal message from you-build customer confidence. Keeps your name before the public weekly. **PROVEN RESULTS.** Thirty ads with instructions \$19.95 Sample \$1.00 refundable. **TV TIPS**, 430 South Jefferson, Lebanon, Mo. 65536. 11-75-8t

SAMS PHOTOFACTS 1 thru 1325 complete with four 4-drawer metal cabinets, good condition, make offer. Mrs. Robert Perdelwitz, Princeville, Illinois 61559. 309-385-4405. 12-75 1t.

HEATHKIT TV Post-Marker/Sweep Generator model IG-57A complete with all test leads and manual-ready to use. \$140.00. Bailey's TV, 430 S. Jefferson, Lebanon Missouri. 12-75 1t

NEW Canadian Magazine "Electronics Workshop". \$5.00 yearly. Sample \$1.00. Ethko, Box 741, Montreal "A" Canada. 10-75-12t

UNUSUAL SURPLUS AND PARTS Catalog, \$1. EICO Electronics Dept. E.S., Box 741, Montreal "A" H3C 2V2. 12-74-12t

CONVERT any transistorized T.V. tuner to a tuner substituter. Plans \$2.00. New accelerated Radio & T.V. course. **RADIO TELEVISION TRAINING**, Box 279, ES-105, Syracuse, N.Y. 13206. 8-75-tf

OLDER & OBSOLETE Radio and TV tubes all new and boxed. We have several thousand. Send for list & prices. Garrett, P.O. Box 2055, San Diego, California 92112. 12-75 2t

FOR SALE (CONT.)

CALIFORNIA BOUND? Take over established TV/HiFi shop on easy terms. Nets \$20,000+. Box 157, Palo Alto, 94301. (415) 327-5320. 12-75 3t

SUPREME Radio-Television Diagram service manuals, like new, cost \$84.50, want \$39, postpaid. Lawrence Beitman, 409-E Chalmers, Champaign, Ill. 61820. 1-76-1t

TEKTRONIX SCOPES—Hewlett-Packard generators, other test and electronic equipment parts, tubes, "ham" supplies, surplus, and older parts. **ELECTRONIC SPECIALTIES**, 1659 W. Wetmore, Tucson, Az. 85705. (602) 887-9729. 1-76-12t

ESTABLISHED BUSINESS FOR SALE—All equipment and stock asking \$10,000. Paul Huston, 430 E. Mulberry St., Lancaster, Ohio 43130. 1-76-1t

FOR SALE—Eighty assorted Sams' Photofacts, used, #600 thru 1244. Best offer. I. Horowitz, 1775 E. 17th St., Brooklyn, N.Y. 11229. 1-76-1t

COLOR PICTURE TUBE BRIGHTENERS.— \$2.95 ppd. while they last. Specify 21" or 23" base. Econo-Vision, 6035 Beach Blvd. Buena Park, Calif. 90621. 1-76-1t

TUBES, ANTIQUE, oddball, SASE for quotations. Laketronics, R #1, New Carlisle, Ohio 45344. 1-76-2t

CRT REBUILDING EQUIPMENT—Accessories included. Complete outfit \$5,000 worth, now only \$3,500.00. Used about 8 months. Lakeside Brand, Gainesville, Fla. 32601. (904) 375-8833. 1-76-2t

WELL ESTABLISHED thriving television sales and service shop - Fully equipped - For Van - Located in progressive university town - near St. Louis, Mo. - Choice location - carpeted showroom. Write: Dept. 507, Electronic Servicing, 1014 Wyandotte St., Kansas City, Mo. 64105. 1-76-1t

ELECTRICAL & Electronic spare parts - excess, lots of 500, 1000 lbs. etc. 609-886-5307. 1-76-1t

EDUCATION-INSTRUCTION

REPAIR TV TUNERS—High Earnings; Complete Course Details. 12 Repair Tricks. Many Plans, Two Lessons, all for \$2. Refundable. Frank Bocek, Box 3236 Enterprise, Redding, Calif. 96001. 10-75-6t

HEATH TRANSISTOR Course with kit \$25 - How to understand your oscilloscope with kit \$15 - 600 Sams Photofacts \$100. Horsley, 67 Theodore St., Buffalo, N.Y. 14211. 1-76-1t

WANTED

TV PROBLEMS?? Send symptoms with a copy of schematic and self-addressed stamped envelope and \$2.00 to Troubleshooter, Box 4553, Downey, Ca. 90241. Results Guaranteed. 9-75-1t

SIGNATURE—LOANS: \$100 - \$25,000, no collateral. (\$3.00) refundable. Tayo Paul, 980 Greene Ave., Brooklyn, N.Y. 11221. 11-75-3t

NEEDED: Schematics, diagrams, articles, books. Anything on those early scanning disc TV sets. Early popular electronic books. Auman TV Serv., Rt. 1 Box 368, Dover, Ohio 44622. 1-76-1t

WANTED—B&K VO Matic 360 or good meter movement for one. Write Bill Simmons TV, 27 Broad St., St. Lyons, N.Y. 14489. 1-76-1t

BUSINESS OPPORTUNITY

TV TECHNICIANS: Broadcast engineers fix equipment quickly. So will you if you qualify for my "Tough Dog" TV repair (and "hard to get" parts) WATS telephone assistance program. Send resume and credit references to Melvin Cohen, Television Broadcast Engineer, May Company Building, 3651 Prospect Avenue, Riviera Beach, Fla. 33404. Enclose 13 cents addressed envelope. 1-76-2t

BUSINESS OPPORTUNITY

TV SERVICE Established 18 yrs.; room for sales. Moving from area: Hal Tolmas TV, 9514 Reseda Blvd., Northridge Calif. 91324. Suburb of Los Angeles. 1-76-1t

EXPERT TV Technicians needed to repair and update master antenna systems with new patented method. No previous experience as I will train you the "right way" the first time. No competition, as you will be one of a select number directly under my technical assistance tied together with a Wats Telephone. Earning potential? Over \$200.00 per day. Send complete resume and credit references. Melvin Cohen, Television Broadcast Engineer, May Company Building, 3651 Prospect Avenue, Riviera Beach, Fla. 33404. Be Patient for my reply. Enclose 13 cent addressed envelope. 11-75-4t

advertisers' index

American Technology Corp.	13
Antenna, Inc.	29
B & K Div., Dynascan Corp.	7
Bussman Mfg. Div., McGraw-Edison	3
Castle Electronics, Inc.	Cover 4
Charous & Niebergall	52
Cost Effective Components	35
John Fluke Mfg. Co., Inc.	21
Gem City Tuner	10
Hickok Electrical Instruments Co.	28
Jerrold Electronics	1
Lectrotech, Inc.	12
Mountain West Alarm Supply Co.	53
Oelrich Publications	53
Perma-Power Co.	51
Precision Tuner Service	Cover 2
Sperry Tech, Inc.	16
Tuner Service Corp.	5
Winegard	Cover 3

Wishing...
doesn't make
it so!
Birth defects
are forever.
Unless
you help.
March of Dimes

THIS SPACE CONTRIBUTED BY THE PUBLISHER

TO: JOE RIDGE
WINEGARD SALES MANAGER

FIRST REPORTS FROM FIELD REALLY FANTASTIC!
INSTALLERS SAY WE HAVE A REAL WINNER IN
CHROMSTAR--MORE POWERFUL PERFORMANCE, ESPECIALLY
UHF--STRONGEST ANTENNA EVER BUILT--EASIER
INSTALLATION. ACCEPTANCE AND DEMAND HIGH AND
GROWING . . . KEEP 'EM COMING!

DISTRIBUTORS PLEASSED WITH DEALER REACTION, AND
HAPPY WITH NEW, COMPACT CARTON SIZES. SET
OWNERS GETTING CLEARER PICTURES, BETTER COLOR
FROM ALL STATIONS IN RANGE. AM SENDING YOU
ACTUAL DEALER STATEMENTS.

LEO RIDDLE
DISTRICT MANAGER



Dealers Everywhere Welcome CHROMSTAR™ First New TV Antennas In Years.

Response has been totally enthusiastic because of the
many far-ahead features built into Chromstar models!

- New Standard of Excellence In Construction and Performance.
- Anodized and Ruggedized for Weather Protection, Long Life.
- New Tri-Linear UHF Director System Increases Gain Up To 30%
- Models To Solve Every Reception Problem.

GET ALL THE FACTS FROM YOUR WINEGARD DISTRIBUTOR.
FREE SPEC CHARTS ON ALL MODELS. CASH IN WITH
CHROMSTAR SALES AND INSTALLATIONS!

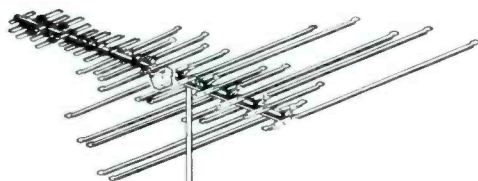

CH-7080
VHF-UHF-FM

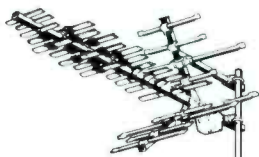

CH-9085
UHF only

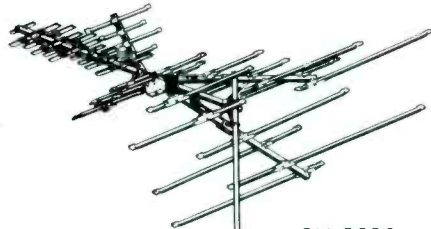

CH-8096
VHF-UHF-FM



WINEGARD®
C O M P A N Y

3000 Kirkwood • Burlington, Iowa 52601

TV ANTENNAS MORE PEOPLE LOOK UP TO.

For More Details Circle (2) on Reply Card

You enjoyed the **TIMESAVING** advantages of the previous models of the Castle Subber® analyst . . . **NOW** you will want to move up to this superior, redesigned model . . . our best yet!

SUBBER®

Mark IV-CUV

*UHF-VHF tuner
and i-f analyst*

net \$64.95



If you haven't joined the ranks of thousands of professional technicians using this **TIMESAVING** instrument . . . **NOW** is your opportunity to own the latest model boasting these improved features:

- **TUNES ALL VHF & UHF CHANNELS.** Use where prime signals are on either VHF or UHF . . . or both.
- **ELECTRONIC FINE TUNING.** Smooth, exact tuning ensures precise setting for ease in testing color receivers.
- **DUAL 40MHz IF OUTPUT JACKS.** Select Hi or Lo impedance output for best coupling match to circuit being substituted . . . tube or transistor.
- **BATTERY CONDITION INDICATOR.** IC comparator driven LED shows when inbuilt 9v transistor batteries require replacement.

The Mark IV-CUV tunes all 82 VHF & UHF channels for substitution tests of the tuners and entire i-f system of any 40MHz TV receiver. Permits signal injection after the agc controlled stages for the high speed agc system analyzing procedure invented by Castle . . . the first practical method for analyzing agc system defects without confusion.

Mark IV-C

The Mark IV-C tunes all 12 VHF channels for substitution injection tests of the VHF tuner, UHF tuner and entire i-f system of any 40MHz TV receiver.

- **ELECTRONIC FINE TUNING.**
- **DUAL 40MHz IF OUTPUT JACKS.** Battery & 120-vac line powered.
- **BATTERY CONDITION INDICATOR.**

net \$54.95

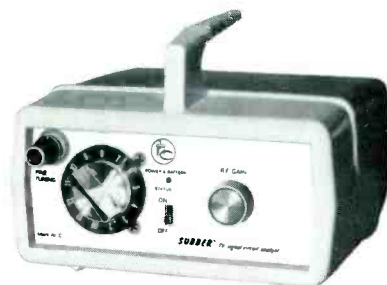

Made in USA.



See your stocking distributor . . . or write for more details and complete specifications.

CASTLE ELECTRONICS, INC. 5701 N. Western Ave., Chicago, Ill. 60645 • Ph. (312) 728-1800

For More Details Circle (3) on Reply Card